

# 10

## Electric Current and its Effects



0758CH14

You might have tried the game 'How steady is your hand?' suggested in Chapter 9 of Class VI. If not, you may try it out now. Paheli and Boojho had also set up the game by connecting an electric circuit as suggested in Class VI. They had lots of fun trying it out with their families and friends. They enjoyed it so much that they decided to suggest it to a cousin of theirs who stayed in a different town. So, Paheli made a neat drawing showing how the various electric components were to be connected (Fig.10.1).

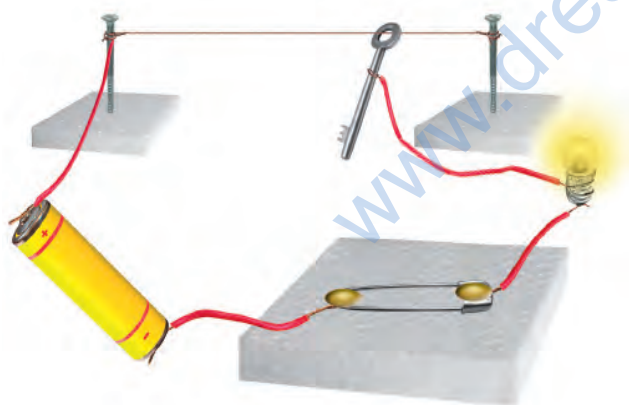

Fig. 10.1 Setup to check how steady your hand is

Can you draw this circuit conveniently? It made Boojho wonder if there was an easier way to represent these electric components.

### 10.1 SYMBOLS OF ELECTRIC COMPONENTS











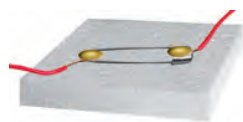

Some common electric components can be represented by symbols. In Table 10.1, some electric components and their symbols are shown. You may come across different symbols for these components in different books. However, in this book, we shall be using the symbols shown here.

Look at the symbols carefully. In the symbol for the electric cell, notice that there is a longer line and a shorter but thicker parallel line. Do you recall that an electric cell has a positive terminal and a negative terminal? In the symbol of the electric cell, the longer line represents the positive terminal and the thicker, shorter line represents the negative terminal.

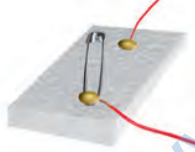
For a switch the 'ON' position and the 'OFF' position are represented by the symbols as shown. The wires used to connect the various components in a circuit are represented by lines.

In Table 10.1, a battery and its symbol are also shown. Do you know what a *battery* is? Look at the symbol of a battery. Can you make out what a battery could be? For some of the activities we may need more than one cell. So, we connect two or more cells together as shown in Fig.10.2. Notice

**Table 10.1 Symbols for some electric circuit components**

S.No.	Electric component	Symbol
1.	Electric cell 	
2.	Electric bulb 	
3.	Switch in 'ON' position 	
4.	Switch in 'OFF' position 	
5.	Battery 	
6.	Wire 	

that the positive terminal of one cell is connected to the negative terminal of the next cell. Such a combination of two or more cells is called a **battery**.

Many devices such as torches, transistors, toys, TV remote controls, use batteries. However, in some of these devices the electric cells are not always placed one after the other as shown in Fig. 10.2. Sometimes the cells are placed side by side. Then how are the terminals of the cells connected? Look carefully inside the battery compartment of any device. There is usually a thick wire or a metal strip connecting the positive terminal of one cell to the negative terminal of the next cell (Fig.10.3). In order to help you to place the cells correctly in the battery compartment, '+' and '-' symbols are usually printed there.

How can we connect the cells to prepare batteries for our activities? You may make a cell holder, as shown in Fig.10.4, using a wooden block, two iron strips and rubber bands. It is necessary



*Fig. 10.2 (a) A battery of two cells  
(b) A battery of four cells*



*Fig. 10.3 Connecting two cells together to make a battery*

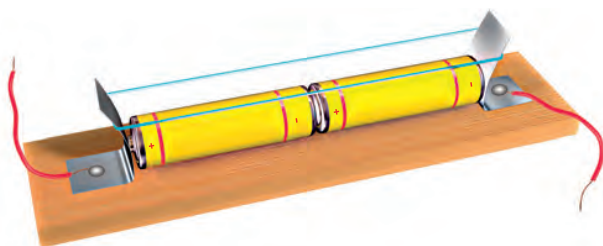

*Fig. 10.4 A cell holder*

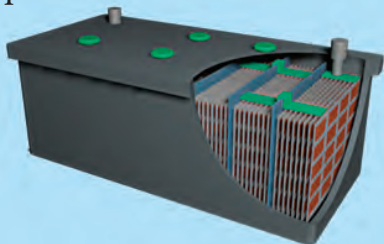

*Fig. 10.5 Another type of cell holder*

that the rubber bands hold the metal strips tightly.

You could also buy cell holders from the market for making batteries of two or more electric cells. Place the cells in them properly, such that the positive

Paheli and Boojho wonder whether the batteries used in tractors, trucks and inverters are also made from cells. Then why is it called a battery? Can you help them to find the answer to this question?



*Fig. 10.6 Truck battery and its cutout*

terminal of one cell is connected to the negative terminal of the next cell. Connect a piece of wire each to the two metal clips on the cell holder as shown in Fig.10.5. Your battery is ready for use.

The symbol used for representing a battery is shown in Table.10.1.

Let us now draw a circuit diagram of an electric circuit using symbols shown in Table 10.1.

### Activity 10.1

Make the electric circuit shown in Fig. 10.7. You used a similar circuit in Class VI to make an electric bulb glow. Do you remember that the bulb glows only when the switch is in the 'ON' position? The bulb glows as soon as the switch is moved to the 'ON' position.

Copy this electric circuit in your notebook. Make also a circuit diagram of this circuit using symbols for the various electric components.

Is your diagram similar to the one shown in Fig. 10.8?

It is much easier to draw a circuit diagram using symbols. Therefore, we generally represent an electric circuit by its circuit diagram.

Fig. 10.9 shows another circuit diagram. Is it identical to the circuit diagram shown in Fig.10.8? In which way is it different?

Would the bulb glow in this electric circuit? Recall that the bulb glows only when the switch is in the 'ON' position and the electric circuit is closed.

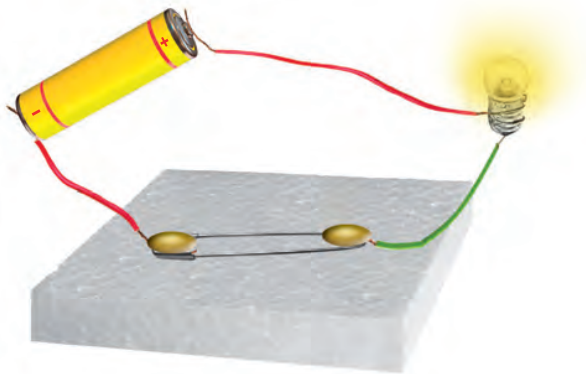

Fig. 10.7 An electric circuit

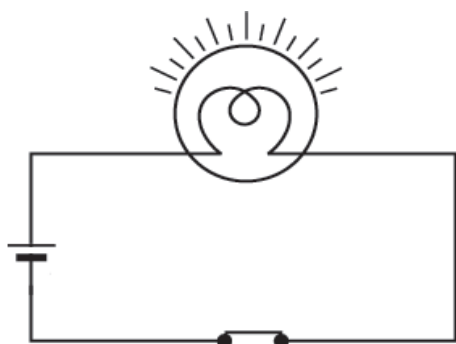

Fig. 10.8 Circuit diagram of electric circuit shown in Fig. 10.7

- Notice that the key or switch can be placed anywhere in the circuit.
- When the switch is in the 'ON' position, the circuit from the positive terminal of the battery to the negative terminal is complete. The circuit is then said to be closed and the current flows throughout the circuit instantly.
- When the switch is in the 'OFF' position, the circuit is incomplete. It is said to be open. No current flows through any part of the circuit.

In the bulb there is a thin wire, called the filament, which glows when an

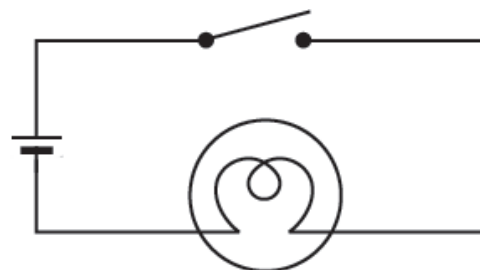

Fig. 10.9 Another circuit diagram

electric current passes through it. When the bulb gets fused, its filament is broken.

### CAUTION

Never touch a lighted electric bulb connected to the mains. It may be very hot and your hand may get burnt badly. Do not experiment with the electric supply from the mains or a generator or an inverter. You may get an electric shock, which may be dangerous. Use only electric cells for all the activities suggested here.

If the filament of the bulb is broken, would the circuit be complete? Would the bulb still glow?

You might have noticed that a glowing electric bulb become warm. Do you know why?

## 10.2 HEATING EFFECT OF ELECTRIC CURRENT

### Activity 10.2

Take an electric cell, a bulb, a switch and connecting wires. Make an electric circuit as shown in Fig.10.9. This activity has to be done using only one cell. Keep the switch in the 'OFF'

position. Does the bulb glow? Touch the bulb. Now move the electric switch to the 'ON' position and let the bulb glow for a minute or so. Again touch the bulb. Do you feel any difference? After moving the switch back to the 'OFF' position, touch the bulb again.

### Activity 10.3

Make a circuit as shown in Fig.10.10. Take about 10 cm long piece of nichrome wire and tie it between the nails. (You can get nichrome wire from an electric repair shop or you can use a piece of discarded coil of an electric heater.) Touch the wire. Now switch on the current in the circuit by moving the switch to the 'ON' position. After a few

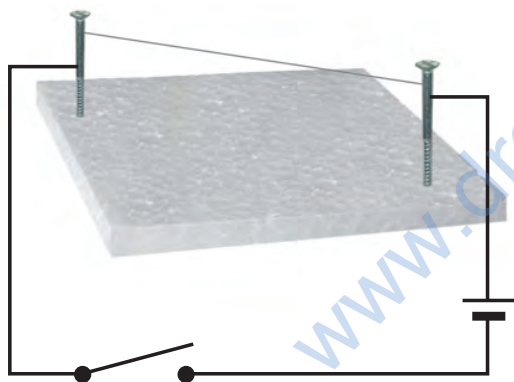

Fig. 10.10

#### CAUTION

Do not keep the switch in the 'ON' position for a long time, otherwise the cell may become weak very quickly.

seconds touch the wire. **(Do not hold it for a long time.)** Switch off the current. Touch the wire again after a few minutes.

The wire gets hot when an electric current passes through it. **This is the heating effect of the electric current.** Can you think of any electric appliance where the heating effect of the electric current is used? Make a list of such appliances.



You might have seen an electric room heater or an electric heater used for cooking. All these contain a coil of wire. This coil of wire is called an **element**. You may have noticed that when these appliances are switched on after

Boojho could not see element in an electric iron. Paheli told him that electrical appliances, such as immersion heaters, hotplates, irons, geysers, electric kettles, hair dryers, have elements inside them. Have you ever seen the element in any appliance?



Fig. 10.11 Element of electric iron





*Fig. 10.12* Glowing filament of an electric bulb (incandescent)

connecting to the electric supply, their elements become red hot and give out heat.

The amount of heat produced in a wire depends on its material, length and thickness. Thus, for different requirements, the wires of different materials and different lengths and thicknesses are used.

The wires used for making electric circuits do not normally become hot. On the other hand, the elements of some electric appliances become so hot that they are easily visible. The filament of

Incandescent electric bulbs (Fig. 10.12) are often used for lighting but they also give heat. It means that a part of electricity consumed is used in producing heat. This is not desirable as it results in the wastage of electricity. The fluorescent tube-lights and compact fluorescent lamps (CFLs) are better electricity efficient lighting sources. Nowadays, the use of light emitting diode (LED) bulbs is increasing. For producing a given intensity of light, LED bulbs consume less electricity as compared to incandescent bulbs or fluorescent tubes or CFLs. Thus LED bulbs are much electricity efficient and therefore being preferred.

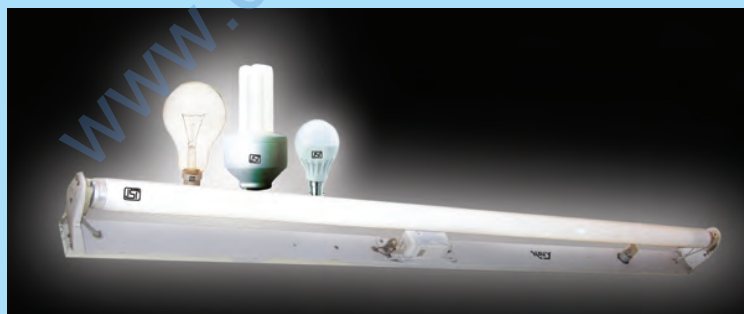

*Fig. 10.13* Electric bulb, tube-light, CFL and LED

It is advised to use electrical appliances and gadgets, which are electricity efficient. Bureau of Indian Standards, New Delhi assigns a Standard Mark on products, called ISI mark  which is an assurance of conformity to the specifications given on the products. It is therefore suggested to use ISI mark products.

Note: Fluorescent tubes and CFLs contain mercury vapour, toxic in nature. Therefore, damaged fluorescent tubes or CFLs need to be disposed off safely.



*Fig. 10.14 Fuse used in buildings*

an electric bulb gets heated to such a high temperature that it starts glowing.

If a large current passes through a wire, the wire may become so hot that it may even melt and break. But is it possible for a wire to melt and break? Let us check it out.

### Activity 10.4

Make the circuit we used for Activity 10.3 again. However, replace the cell with a battery of four cells. Also, in place of the nichrome wire, tie a thin strand of steel wool. (The steel wool is commonly used for cleaning utensils and is available in grocery shops.) If there are any fans in the room, switch them off. Now pass the current through the circuit for sometime. Observe the strand of steel wool carefully. Note what happens. Does the strand of steel wool melt and break?

Wires made from some special materials melt quickly and break when large electric currents are passed through them. These wires are used for making **electric fuses** (Fig.10.14). In all



*Fig. 10.15 Fuses used in electrical appliances*

buildings fuses are inserted in all electrical circuits. There is a maximum limit on the current which can safely flow through a circuit. If by accident the current exceeds this safe limit, the wires

#### CAUTION

Never try to investigate an electric fuse connected to mains circuit on your own. You may, however, visit an electric repair shop and compare the burnt out fuses with the new ones.

One reason for excessive currents in electrical circuits is the direct touching of wires. This may happen if the insulation on the wires has come off due to wear and tear. This may cause a short circuit. Another reason for excessive current can be the connection of many devices to a single socket. This may cause overload in the circuit. You might have read reports in newspapers about fires caused by short circuits and overloads.

may become overheated and may cause fire. If a proper fuse is there in the circuit, it will blow off and break the circuit. A fuse is thus a safety device which

These days Miniature circuit breakers (MCBs) are increasingly being used in place of fuses. These are switches which automatically turn off when current in a circuit exceeds the safe limit. You turn them on and the circuit is once again complete. Look for ISI mark on MCBs also.

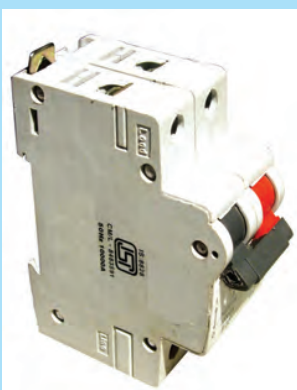

**Fig. 10.16** Miniature circuit breaker (MCB)

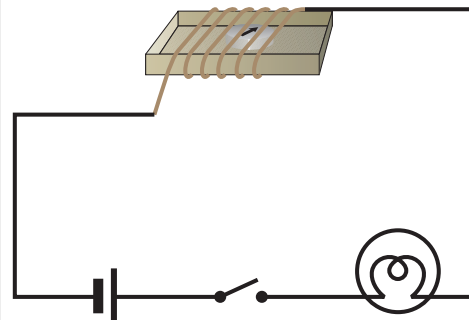

**Fig. 10.17** Effect of current on a compass needle

### CAUTION

Always, use proper fuses which have been specified for particular applications, carrying ISI mark. Never use just any wire or strip of metal in place of a fuse.

prevents damages to electrical circuits and possible fires.

Fuses of different kinds are used for different purposes. Fig. 10.14 shows fuses used in our houses. Fuses shown in Fig. 10.15 are generally used in electrical appliances.

We observed the heating effect of the electric current and learnt how we use it to our advantage. Does the electric current have other effects also?

## 10.3 MAGNETIC EFFECT OF ELECTRIC CURRENT

### Activity 10.5

Take the cardboard tray from inside a discarded matchbox. Wrap an electric

wire a few times around the cardboard tray. Place a small compass needle inside it. Now connect the free ends of this wire to an electric cell through a switch as shown in Fig. 10.17.

Note the direction in which the compass needle is pointing. Bring a bar magnet near the compass needle. Observe what happens. Now, while watching the compass needle carefully, move the switch to the 'ON' position.



**Fig. 10.18** Hans Christian Oersted  
(A.D. 1777-1851)



What do you observe? Does the compass needle deflect? Move the switch back to the 'OFF' position. Does the compass needle come back to its initial position?

Repeat the experiment a few times. What does this experiment indicate?

We know that the needle of a compass is a tiny magnet, which points in north-south direction. When we bring a magnet close to it, the needle gets deflected. We have also seen that compass needle gets deflected when the current flows in a nearby wire. Can you connect the two observations? When the current flows through a wire, does the wire behave like a magnet?

This is what a scientist called **Hans Christian Oersted** (Fig. 10.18) also wondered. He was the first person who noticed the deflection of compass needle every time the current was passed through the wire.

So, when electric current passes through a wire, it behaves like a magnet. This is the magnetic effect of the electric current. In fact, an electric current can be used to make magnets. Do you find it too surprising? Let us try it out.

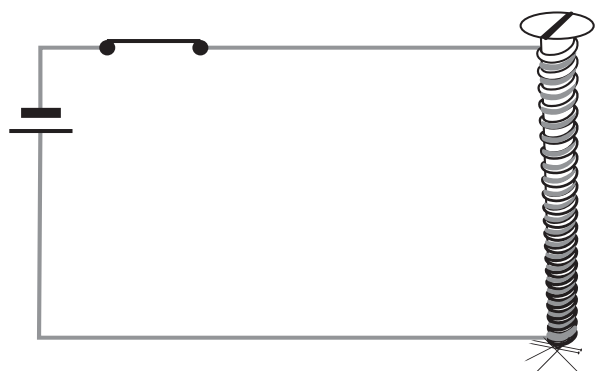

Fig. 10.19 An electromagnet

Remember not to switch on the current for more than a few seconds at a time. The electromagnet weakens the cell quickly if left connected.

## 10.4 ELECTROMAGNET

### Activity 10.6

Take around 75 cm long piece of insulated (plastic or cloth covered or enamelled) flexible wire and an iron nail, say about 6–10 cm long. Wind the wire tightly around the nail in the form of a coil. Connect the free ends of the wire to the terminals of a cell through a switch as shown in Fig. 10.19.

Place some pins on or near the end of the nail. Now switch on the current. What happens? Do the pins cling to the tip of the nail? Switch off the current. Are the pins still clinging to the end of the nail?

The coil in the above activity behaves like a magnet when electric current flows through it. When the electric current is switched off, the coil generally loses its magnetism. Such coils are called **electromagnets**. The electromagnets can be made very strong and can lift very heavy loads. Do you remember the crane about which you read in Chapter 10 of Class VI? The end of such a crane has a strong electromagnet attached to it. The electromagnets are also used to separate magnetic material from the junk. Doctors use tiny electromagnets to take out small pieces of magnetic material that have accidentally fallen in

the eye. Many toys also have electromagnets inside them.

## 10.5 ELECTRIC BELL

We are quite familiar with an electric bell. It has an electromagnet in it. Let us see how it works.

Fig. 10.20 shows the circuit of an electric bell. It consists of a coil of wire wound on an iron piece. The coil acts as an electromagnet. An iron strip with a hammer at one end is kept close to



Fig. 10. 20 Circuit of an electric bell

the electromagnet. There is a contact screw near the iron strip. When the iron strip is in contact with the screw, the current flows through the coil which becomes an electromagnet. It, then, pulls the iron strip. In the process, the hammer at the end of the strip strikes the gong of the bell to produce a sound. However, when the electromagnet pulls the iron strip, it also breaks the circuit. The current through the coil stops flowing. Will the coil remain an electromagnet?

The coil is no longer an electromagnet. It no longer attracts the iron strip. The iron strip comes back to its original position and touches the contact screw again. This completes the circuit. The current flows in the coil and the hammer strikes the gong again. This process is repeated in quick succession. The hammer strikes the gong every time the circuit is completed. This is how the bell rings.

### Keywords

Battery

Circuit diagram

Electric components

Electric bell

Electromagnet

Fuse

Heating effect of current

Magnetic effect of current

### What you have learnt

- It is convenient to represent electric components by symbols. Using these, an electric circuit can be represented by a circuit diagram.
- When an electric current flows through a wire, the wire gets heated. It is the heating effect of current. This effect has many applications.

- Wires made from some special materials melt quickly and break when large electric currents are passed through them. These materials are used for making electric fuses which prevent fires and damage to electric appliances.
- When an electric current flows through a wire, it behaves like a magnet.
- A current carrying coil of an insulated wire wrapped around a piece of iron is called an electromagnet.
- Electromagnets are used in many devices.

## Exercises

1. Draw in your notebook the symbols to represent the following components of electrical circuits: connecting wires, switch in the 'OFF' position, bulb, cell, switch in the 'ON' position, and battery
2. Draw the circuit diagram to represent the circuit shown in Fig.10.21.

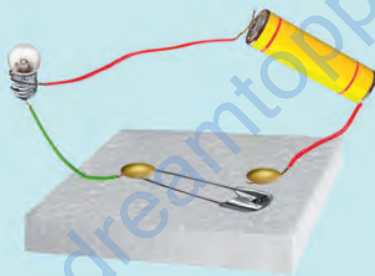

*Fig. 10.21*

3. Fig.10.22 shows four cells fixed on a board. Draw lines to indicate how you will connect their terminals with wires to make a battery of four cells.



*Fig. 10.22*

4. The bulb in the circuit shown in Fig.10.23 does not glow. Can you identify the problem? Make necessary changes in the circuit to make the bulb glow.

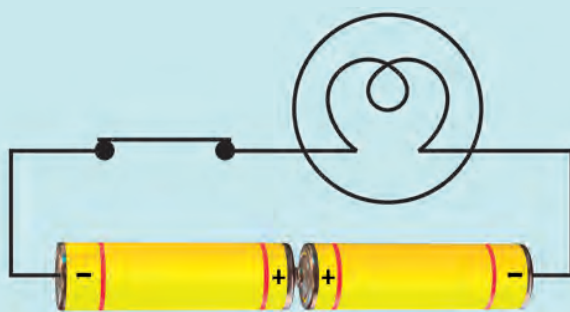

*Fig. 10.23*

5. Name any two effects of electric current.
6. When the current is switched on through a wire, a compass needle kept nearby gets deflected from its north-south position. Explain.
7. Will the compass needle show deflection when the switch in the circuit shown by Fig.10.24 is closed?



*Fig. 10.24*

8. Fill in the blanks:
  - (a) Longer line in the symbol for a cell represents its \_\_\_\_\_ terminal.
  - (b) The combination of two or more cells is called a \_\_\_\_\_ .
  - (c) When current is switched 'on' in a room heater, it \_\_\_\_\_ .
  - (d) The safety device based on the heating effect of electric current is called a \_\_\_\_\_ .
9. Mark 'T' if the statement is true and 'F' if it is false:
  - (a) To make a battery of two cells, the negative terminal of one cell is connected to the negative terminal of the other cell. (T/F)
  - (b) When the electric current through the fuse exceeds a certain limit, the fuse wire melts and breaks. (T/F)
  - (c) An electromagnet does not attract a piece of iron. (T/F)
  - (d) An electric bell has an electromagnet. (T/F)
10. Do you think an electromagnet can be used for separating plastic bags from a garbage heap? Explain.

11. An electrician is carrying out some repairs in your house. He wants to replace a fuse by a piece of wire. Would you agree? Give reasons for your response.
12. Zubeda made an electric circuit using a cell holder shown in Fig. 10.4, a switch and a bulb. When she put the switch in the 'ON' position, the bulb did not glow. Help Zubeda in identifying the possible defects in the circuit.
13. In the circuit shown in Fig. 10.25

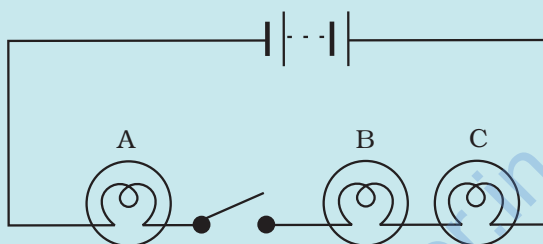

**Fig. 10.25**

- (i) Would any of the bulb glow when the switch is in the 'OFF' position?
- (ii) What will be the order in which the bulbs A, B and C will glow when the switch is moved to the 'ON' position?

### Extended Learning — Activities and Projects

1. Set up the circuit shown in Fig. 10.17 again. Move the key to 'ON' position and watch carefully in which direction the compass needle gets deflected. Switch 'OFF' the current. Now keeping rest of the circuit intact, reverse the connections at the terminal of the cell. Again switch 'on' the current. Note the direction in which the needle gets deflected. Think of an explanation.

Paheli and Boojho saw a magic trick sometime back. The magician placed an iron box on a stand. He then called Boojho and asked him to lift the box. Boojho could easily lift the box. Now the magician made a show of moving his stick around the box while muttering some thing. He again asked Boojho to lift the box. This time Boojho could not even move it. The magician again muttered some thing and now Boojho could lift the box.

The audience, including Paheli and Boojho, were very impressed with the show and felt that the magician had some supernatural powers. However, after reading this chapter Paheli is wondering if the trick was indeed some magic or some science was involved? Can you guess what science might be involved?



2. Make four electromagnets with 20, 40, 60 and 80 turns. Connect them one by one to a battery of 2 cells. Bring the electromagnet near a box of pins. Count the number of pins attracted by it. Compare the strengths of the electromagnets.
3. Using an electromagnet, you can make a working model of a railway signal as shown in Fig.10.26.

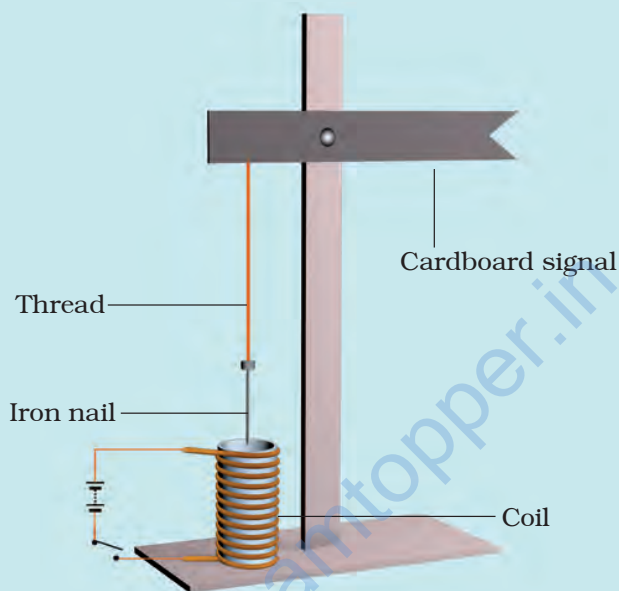
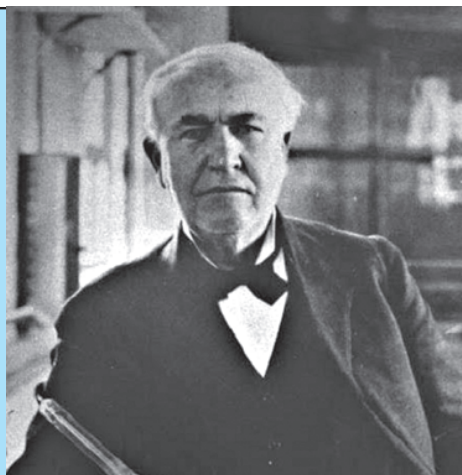

*Fig. 10.26 A working model of a railway signal*

4. Visit an electric shop. Request an electrician to show you the various types of fuses and MCB and to explain how they work.

### Did you know?

The credit for the invention of the electric bulb is usually given to Thomas Alva Edison, though others before him had worked on it. Edison was a remarkable man. He made some 1300 inventions including the electric bulb, gramophone, the motion picture camera and the carbon transmitter, which facilitated the invention of the telephone.



*Fig. 10.27 Thomas Alva Edison  
(A.D. 1847 – 1931)*