

THEME

5

HOW THINGS WORK

ACTIVITY 41



WHAT WE HAVE TO DO?

Make a bulb glow with the help of a few cells and a few pieces of wire.



WHAT DO WE NEED?

A few dry cells, an LED, connecting wires, safety pins, a few drawing pins, a piece of thermocol, a piece of thick cotton connecting wire, a candle, a match box and cello tape.



HOW DO WE PROCEED?

For making a switch:

1. Fix one end of a safety pin on the piece of thermocol with the help of a drawing pin.
2. Fix another drawing pin on the thermocol in such a way that the free end of the safety pin touches it when brought closer to it. This setup can be used as a switch as shown in Fig. 41.1.

For making the circuit:

3. Take three pieces of connecting wires. Remove the plastic covering from the ends of each of the three wires.



Figure 41.1 A simple switch

4. Join one end of a wire with the positive terminal of the cell and fix it with the help of cello tape.
5. Join the other end of this wire with one leg of the LED.
6. Take the second piece of wire. Join one of its ends with the other leg of the LED. Fix the other end of the wire to the drawing pin on the switch made by you.
7. Take the third piece of wire and join one of its end to the negative terminal of the cell and the other end to the second drawing pin of the switch (Fig. 41.2).
8. Has the LED started glowing? Is the path for the flow of current complete? Is there any gap left in this arrangement? Is there air in this gap?
9. Now touch the free end of the safety pin with the second drawing pin. Does the LED glow now?
10. Detach the safety pin from the second drawing pin.
11. Drop a few drops of wax on this drawing pin. Now touch the free end of the safety pin with this wax coated drawing pin. Does the LED glow again?
12. Detach the safety pin and remove the wax from the drawing pin. Replace any piece of wire in the set up with a thick cotton thread. Now complete/close the circuit. Does the LED glow now?

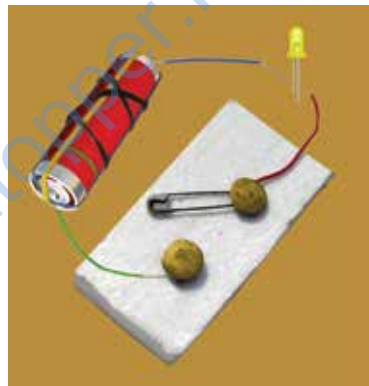

Figure 41.2 An electric circuit with a switch



WHAT DO WE OBSERVE

- (i) The path for the current is closed when the free end of the safety pin is attached to the second drawing pin and the LED starts glowing.
- (ii) The LED does not glow when the switch is closed with the wax coated drawing pin.
- (iii) The LED did not glow when one of the wires was replaced by the cotton thread.



WHAT DO WE CONCLUDE?

- The LED glows when the path for the current gets completed (or the circuit is completed). Materials like metals which allow electric currents to pass through them are called conductors of electricity.

- The insertion of things like wax or cotton thread breaks the circuit and do not allow the current to flow. The LED did not glow in those cases. Substances like plastic, wax, rubber which do not allow the current to pass through them are called insulators.



LET US ANSWER

- Why did the LED not glow when the free end of the safety pin was not touching the drawing pin? What was there in between the safety pin and the drawing pin which prevented the LED to glow?
- How does the bulb of a torch glow when two or three cells are inserted in it? Draw the path of the current passing through the torch.
- Amrita's torch was not working. She bought new cells and inserted them in the torch but the torch bulb still did not glow. Explain the possible reasons.
- Will the order in which the bulb, cell and switch are connected in the circuit affect the passing of current?



WHAT MORE CAN WE DO?

- Try to light a bulb with a cell and one piece of wire.
- Take two cells and arrange them in a circuit as shown in Fig. 41.3. In which of the cases will the bulb glow and why?

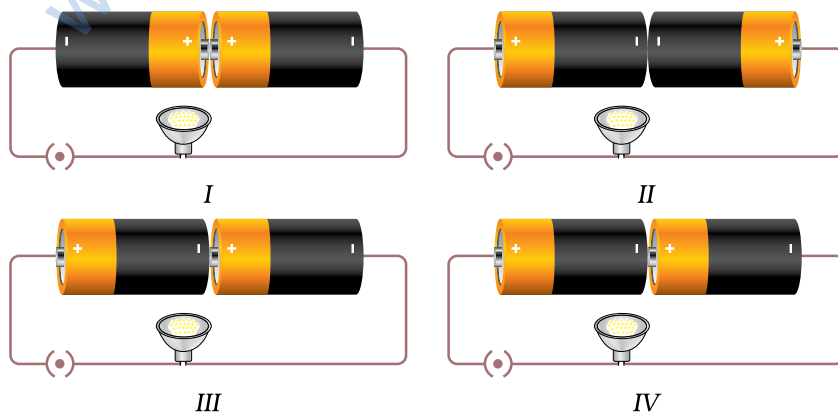

Figure 41.3

- Look at the bulb closely and draw a diagram and label every part of it.

NOTE FOR THE TEACHER

- This activity can be done in groups. Explain to students that every material can conduct electricity under certain conditions and hence we name the material which do not allow current to pass through them as poor (or bad) conductors. The teacher may give the example of lightning through air to elaborate that air does conduct electricity under certain conditions.
- Encourage children to arrange the components of the circuit in different ways changing their order every time. The teacher may draw circuit diagrams on the blackboard to help the students.

NOTES _____

ACTIVITY 42**WHAT WE HAVE TO DO?**

To make a magnet out of the given iron nail and observe its properties.

**WHAT DO WE NEED?**

A few iron nails about 5 cm long, a bar magnet, a circular piece of thermocol (about 6 cm in diameter), a large mug with water, a few pins.

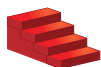
**HOW DO WE PROCEED?**

1. Take an iron nail. Place it on the table.
2. Bring the north pole of the magnet near the head of the nail.
3. Touch the head of the nail with the magnet and drag the magnet along the surface of the nail till the other end.
4. Now lift the magnet and bring the same pole near the head of the nail and repeat the above action.
5. Repeat this process 30-40 times.
6. Bring this nail near a few pins. See if the pins get attracted towards the nail.
7. If the pins are not getting attracted, rub the nail with the magnet a few more time.
8. If the pins are now getting attracted your magnet is ready. You may also call it as nail magnet.
9. Fix this magnet on to the circular thermocol piece with a tape.
10. Place this setup in the mug full of water and swirl it.
11. When the thermocol comes to rest, notice the direction in which the nail is pointing.
12. Swirl the magnet five to six times and notice the direction in which the nail points every time it comes to rest. This direction is the magnetic north-south direction. Can you relate the direction of the nail with any geographical direction?

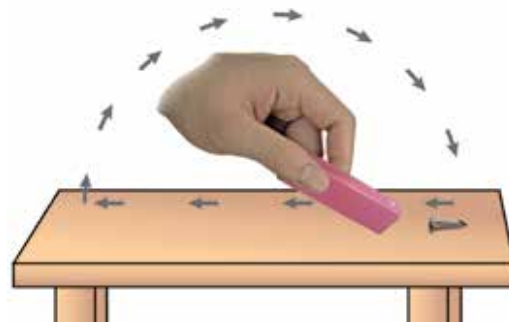

Making your own magnet



A compass in a cup

13. The pole pointing to the north direction is called the north pole. Mark this pole of the magnet with red paint.
14. Bring the north pole of the magnet, near the north pole of the nail magnet.
15. What did you observe? Does the nail magnet get deflected? If yes, note the direction of this deflection.
16. Now, once the nail magnet comes to rest, bring the south pole of the magnet near the north pole of the nail magnet. In which direction did the nail magnet deflect now?



WHAT DO WE OBSERVE?

- The nail magnet comes to rest every time in the same direction which corresponds to the magnetic north-south direction.
- When the south pole of a magnet is brought near the north pole of the nail magnet, it gets attracted.
- When the north pole of the magnet is brought closer to the north pole of the nail magnet, it gets repelled.



WHAT DO WE CONCLUDE?

- A piece of iron can be made into a magnet by rubbing it repeatedly with a magnet.
- A freely rotating suspended magnet always points in the north-south direction.
- Like poles of two magnets repel each other and unlike poles attract each other.



LET US ANSWER

1. Test the magnet made by you after a week and see if it retains its properties.
2. If the magnet made by you is mixed with other similar looking nails, how will you detect your magnet?
3. A sailor has to move towards east direction. How can he use the magnet to find this direction?



WHAT MORE CAN WE DO?

- Try to make a magnet out of a nail made of aluminium or brass. Did you succeed?
- Take a piece of paper. Mark your own position at the centre of it. Now show the direction of the Principal's office, the school ground, the science lab and the school canteen with the help of a magnet.
- Take a fresh nail. Repeat steps 2-5, but this time take the south pole of the magnet for rubbing. Now determine the north pole of this nail magnet. Compare the poles of this magnet with the poles of the magnet you made earlier. Can you relate the poles of a nail magnet with the pole of the magnet you used for rubbing?

NOTE FOR THE TEACHER

- Try to make a magnet out of a nail made of aluminium or brass. Did you succeed?
- Take a piece of paper. Mark your own position at the centre of it. Now show the direction of the Principal's office, the school ground, the science lab and the school canteen with the help of a magnet.
- Take a fresh nail. Repeat steps 2-5, but this time take the south pole of the magnet for rubbing. Now determine the north pole of this nail magnet. Compare the poles of this magnet with the poles of the magnet you made earlier. Can you relate the poles of a nail magnet with the pole of the magnet you used for rubbing?

NOTES

ACTIVITY 43**WHAT WE HAVE TO DO?**

To find out whether both the poles of a magnet are equally strong and whether all magnets are equally strong.

**WHAT DO WE NEED?**

We need a few magnets (say 3-4) of different lengths, few pins (say 15-20) made of iron or steel of equal size, a scale, cellotape.

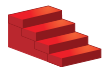
**HOW DO WE PROCEED?**

1. Fix a meter scale on a table with cello tape.
2. Mark magnets as 1, 2, 3, 4.
3. Place magnet-1 along the scale at a fixed point.
4. Place a pin at a distance of about 5 cm from the magnet as shown in Fig. 43.1. Observe what happens. Is the magnet able to attract the pin?
5. Move the pin gradually towards the magnet in small steps. Keep on observing carefully. Is there a point at which the pin is just pulled towards the magnet?
6. Note down this distance of the pin from the magnet in Table 43.1.
7. Now reverse the end of the magnet so that its other pole is facing the pin.
8. Repeat the above steps and note down the distances at which the pin is just pulled towards the magnet.
9. Repeat all the above steps using magnet-2, magnet-3, etc.

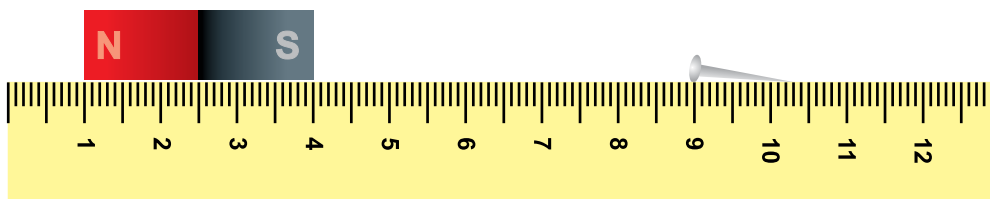

Figure 43.1



WHAT DO WE OBSERVE?

Table 43.1

Magnet No.	Pole facing the pin	Distance at which the pin is pulled towards the magnet (cm)	Tick the correct box
1	N S	d_1 d_2	$d_1 = d_2$ <input type="checkbox"/> $d_1 \neq d_2$ <input type="checkbox"/>
1	N S	d_1 d_2	$d_1 = d_2$ <input type="checkbox"/> $d_1 \neq d_2$ <input type="checkbox"/>
1	N S	d_1 d_2	$d_1 = d_2$ <input type="checkbox"/> $d_1 \neq d_2$ <input type="checkbox"/>
1	N S	d_1 d_2	$d_1 = d_2$ <input type="checkbox"/> $d_1 \neq d_2$ <input type="checkbox"/>

- Do you observe that the distances d_1 and d_2 are equal for both poles of all the magnets?
- Are the distances d_1 and d_2 measured for all the four magnets equal?
- If these distances are not equal, what could be the reason?



WHAT DO WE CONCLUDE?

- In each magnet distances d_1 and d_2 are equal. It shows that both the poles (North pole and South pole) of each magnet are equally strong.
- If distances d_1 and d_2 are not equal for all magnets, it means that the magnets are not equally strong.
- All magnets may or may not be equally strong. Moreover, the strength of a magnet does not depend on its size.



LET US ANSWER

1. Najma observed that a pin is pulled towards a magnet. Which property of the magnet is shown by her observation?
2. Magnet A is able to pull the pin at a distance of 4.0 cm. Magnet B is able to do so as a distance of 3.0 cm. Which magnet is stronger?
3. Magnet A is stronger than magnet B. Which of these will be able to pull the pin from a shorter distance?



WHAT MORE CAN WE DO?

- You can repeat this activity using magnets of different shapes and sizes.
- Repeat this activity by replacing magnet with a sharpener, an eraser and a pencil. Report your conclusions.

NOTE FOR THE TEACHER

- As far as possible children should use pins of the same size and fresh pins every time.
- Instruct children to remove all other magnets and all objects made from magnetic materials from the table where they are working. It may affect their observations.

A game can we played by two teams at a time.

Take several iron-shoe nails or ½-inch screws. Place 10 of these at equal distances from one

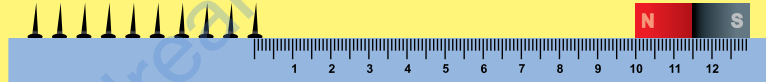

Figure 43.2

another on a smooth surface with their heads down (Fig. 43.2). Take care that the distance between the nails/screws is as small as possible, but they should not touch each other. A member of a team places a magnet at a distance of about 10 cm from the nails/screws. She moves the magnet towards the nails/screws gradually so that only one nail/screw is attracted. The idea is to develop skill so that only one nail/screw is attracted without disturbing the others. The team which is able to attract all the ten nails/screws in the least amount of time will be declared the winner.

ACTIVITY 44**WHAT WE HAVE TO DO?**

To observe the heating effect of electric current.

**WHAT DO WE NEED?**

2 D type 1.5 V cells, cell holder, Plug key/switch, nichrome wire of about 20 cm length, a candle.

**HOW DO WE PROCEED?**

1. Take about 20 cm long nichrome wire. Wrap it over a candle uniformly so that each turn is separate from the other. Now you have made a coil with the candle as its core.
2. Connect any one end of this wire with the positive terminal of the battery and complete the electric circuit as shown in Fig. 44.1.
3. Insert the key in the plug. The electric circuit is closed now.
4. Observe the candle for a few minutes. Does it start to melt around the wire?

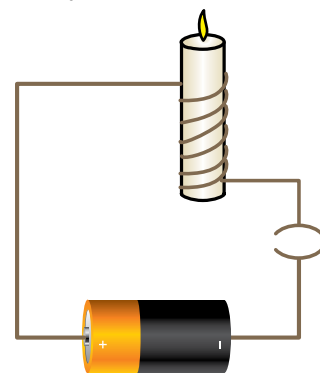

Figure 44.1

**WHAT DO WE OBSERVE?**

- Melting of wax around the wrap produces pattern over the candle.

**WHAT DO WE CONCLUDE?**

- Electric current produces a heating effect in the wire. Hot wire causes the wax to melt.



LET US ANSWER

1. Name three appliances where heating effect of electric current is desirable.
2. Name three electric appliances where heating effect of electric current is undesirable.



WHAT MORE CAN WE DO?

- The activity may be repeated with wires of different lengths/materials.
- Activity may be repeated using 3V battery in the circuit. This new observation may be compared with the activity performed using 9V battery in the circuit. Students may repeat this activity with 1.5V, 3V, 4.5V batteries and report their observations.
- Discussion may be initiated with students on the following points:
 - Does the heat produced in the wire depend on its length?
 - Does the heat produced depend on the material of the wire?
 - Does the heat produced depend the number of cells used?

NOTE FOR THE TEACHER

- A D type cell is a size of drycell. These cells are typically used in high current applications, such as large flashlights, radiorecivers. etc. It is cylindrical with electrical contacts at each end. The positive end has a nod a bump.
- Current should not be passed in the circuit for long duration.
- Care should be taken that students do not touch the wire when circuit is closed as it may hurt them.
- This activity can also be given as a project work to students. They may study various factors on which heating effect of electric current depends. These factors could be the length, thickness and material of the wire and the number of cells used. However, the presence of the teacher is necessary for conducting this activity/project.

ACTIVITY 45**WHAT WE HAVE TO DO?**

To observe how the strength of an electromagnet depends upon the number of turns of the wire.

**WHAT DO WE NEED?**

10 cm long three iron bolts, enamelled copper wire 5 m, a battery of 2 cells, a switch, shoe nails (black iron nails) about 100g, plastic pipe (10 cm), and paper.

**HOW DO WE PROCEED?**

1. Make three electromagnets with 20, 40 and 60 turns. For this wind the enamelled copper wire tightly around the iron bolt in the form of a coil.
2. Rub the free ends of the wires of each electromagnet with the sand paper to remove the enamel coating.
3. Connect the electromagnet with 20 turns to a battery of 2 cells through a switch as shown in Fig. 45.1.
4. Place some shoe nails near the end of the bolt and switch on the current. What happens? Do the nails cling to the bolt? Count the number of nails attracted by this electromagnet.
5. Switch off the current. Now the coil loses most of its magnetism. A few nails may still cling to the electromagnet.
6. Repeat this activity with other electromagnets of 40 and 60 turns with the same set-up.
7. Wind 60 turns of the enamelled copper wire around a plastic pipe instead of an iron bolt and observe if it acts as an electromagnet. Note the number of iron nails it attracts.

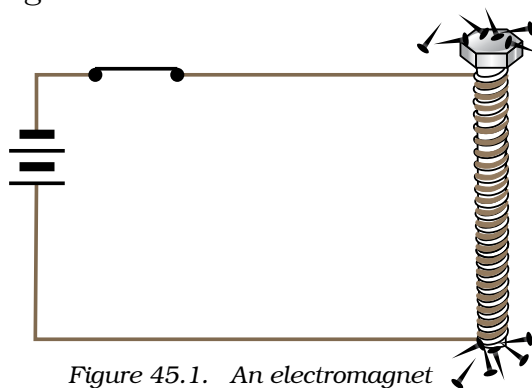

Figure 45.1. An electromagnet



WHAT DO WE OBSERVE?

- The electromagnet loses its magnetism when the electric current is switched off.
- Number of nails attracted by the electromagnet having 40 turns is larger than the number of nails attracted by the electromagnet having 20 turns. Also the number of nails attracted by the electromagnet having 60 turns is larger than the number of nails attracted by the electromagnet having 40 turns.
- Number of nails attracted by the electromagnet with the plastic pipe core was much smaller than when the electromagnet had iron bolt as the core.



WHAT DO WE CONCLUDE?

- A current carrying coil of wire wrapped around a piece of iron works as an electromagnet.
- The strength of an electromagnet depends upon the number of turns of the wire and the core used to make the electromagnet.



LET US ANSWER

1. If you wind an enamelled copper wire around a plastic pipe does it act as a magnet?
2. If we use a plastic pipe instead of the iron bolt, is the magnetic effect as strong as with the iron bolt? Which one of them makes a stronger magnet?
3. List uses of electromagnets.
4. How will you change the strength of an electromagnet without changing the battery provided to you?



WHAT MORE CAN WE DO?

- Repeat this activity by replacing the battery of two cells by a battery of three cells. Do you find any change in the strength of the electromagnet?
- Study the use of electromagnets in some toys available in the market.
- Try the above activity using various iron materials.

ACTIVITY 46**WHAT WE HAVE TO DO?**

Study electrolysis of water.

**WHAT DO WE NEED?**

Water in a 250 mL beaker, common salt, a battery of 3 D type 1.5 V cells, cell holder, double cotton covered copper connecting wires, a switch.

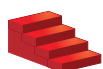
**HOW DO WE PROCEED?**

1. Take two long dcc (double cotton covered) copper wires and fold one end of each into U-shape as shown in Fig 46.1.
2. Fill the beaker about half with water. Add half a teaspoonful of common salt to water to make it more conducting.
3. Insert the U-shaped connecting wire in water. Connect its other end to the positive terminal of the battery.
4. Connect the negative terminal of the battery to a plug key.
5. Connect the second U-shaped connecting wire to the negative terminal of the cell through the key.
6. Insert the key into plug. Wait for a few minutes.
7. The wire connected to the positive terminal of the battery is called the positive electrode and the wire connected to the negative terminal of the battery is called negative electrode.
8. Observe carefully. Do you observe gas bubbles on the electrodes? On which electrode do you observe larger number of bubbles?
9. Now remove the key from the plug. Do you still observe the bubbles on the electrodes?

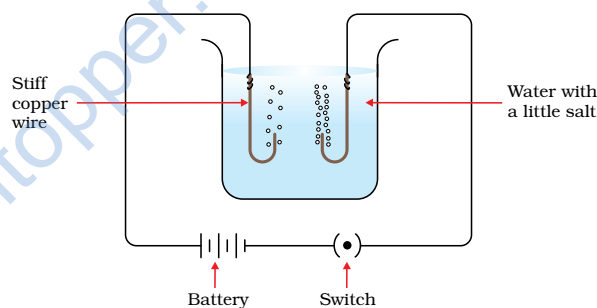

Figure 46.1

**WHAT DO WE OBSERVE?**

- We observe that small bubbles are formed on both the electrodes.
- Smaller number of bubbles are formed on the electrode connected to the positive terminal of the battery. Larger number of bubbles are

formed on the electrode connected to the negative terminal of the battery.

- Bubbles are formed on the electrodes as long as the key remains inserted in the plug.



WHAT DO WE CONCLUDE?

- The passage of an electric current through water causes chemical reaction. As a result bubbles are formed on the electrodes. This is due to the chemical effect of electric current.
- Water molecule (H_2O) has hydrogen and oxygen atoms. When electric current is passed through water, oxygen bubbles are released at the positive electrode and hydrogen bubbles are released at the negative electrode.
- As water molecule has two hydrogen atoms for every oxygen atom, larger number of bubbles are formed at the electrode connected to the negative terminal of the battery.



LET US ANSWER

1. In this experiment, why do we add common salt to water?
2. How can you capture the gas released at both the electrodes?
3. How will you confirm that hydrogen gas is released at the negative electrode?



WHAT MORE CAN WE DO?

- Bubbles released on the electrodes can be collected in a small (glass/ plastic) bottle inverted over the electrodes.
- The distance between the electrodes can be increased and its effect on the number of bubbles released at the electrodes can be studied.
- The activity may be repeated taking water from various sources (tap water, distilled water, river water, etc.) and also by taking electrodes of different materials.

NOTE FOR THE TEACHER

- Care should be taken to avoid excessive flow of current through the circuit. For this a proper resistance may be connected in the electric circuit.
- Keep the two electrodes completely immersed in water.