

CBSE Class-12 Chemistry

Quick Revision Notes

Chapter 14

Biomolecules

- **Carbohydrates:** Polyhydroxy aldehydes or polyhydroxyketones or compounds on hydrolysis give carbohydrates.

- **Classification of carbohydrates:**

Monosaccharides

- (a) Simplest carbohydrates
- (b) It cannot be hydrolysed into simpler compounds
- (c) Examples - Glucose, mannose

Oligosaccharides

- (a) Carbohydrates which gives 2 to 10 monosaccharide units on hydrolysis
- (b) Examples - Sucrose, Lactose, Maltose

Polysaccharides

- (a) Carbohydrates which on hydrolysis give large number of monosaccharide units.
- (b) Examples - Cellulose, starch

- **Anomers:** Pair of optical isomers which differ in configuration only around C1 atom are called anomers. Examples - α -D-glucopyranose and β -D-glucopyranose.
- **Epimers:** Pair of optical isomers which differ in configuration around any other C atom other than C1 atom are called epimers. E.g. D-glucose and D-mannose are C2epimers.

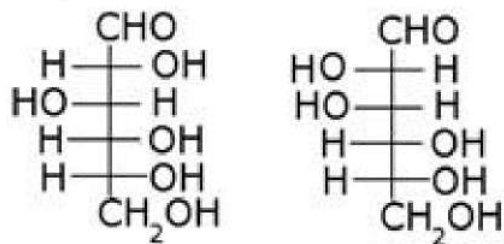

D - Glucose

D - Mannose

- **Preparation of glucose (also called dextrose, grape sugar):**

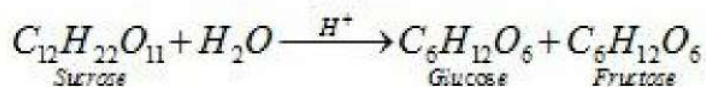

- From starch

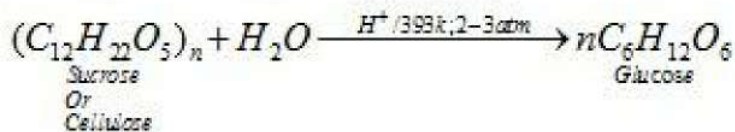

- Structure of glucose

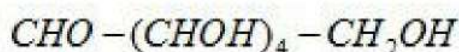

- Structure elucidation of glucose:

a) D - glucose with HI

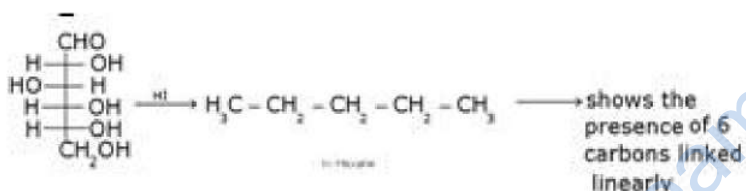

b) D - glucose with HCN

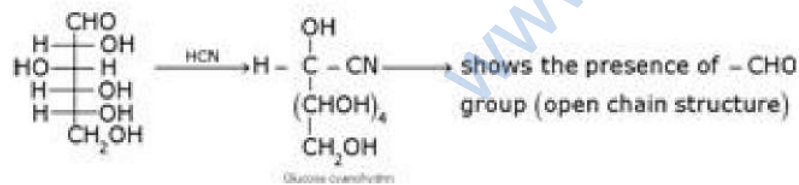

c) D - glucose with NH₂OH

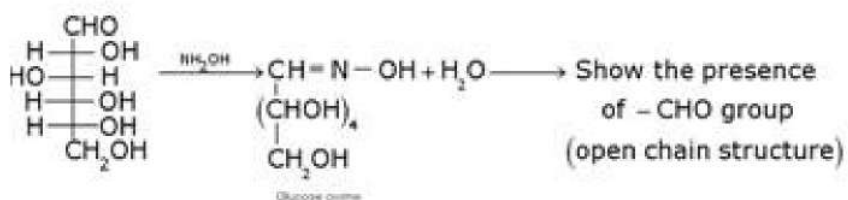

d) D- glucose with Fehling's reagent

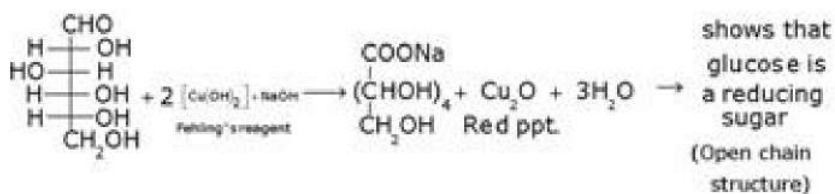

e) D - glucose with Tollen's reagent

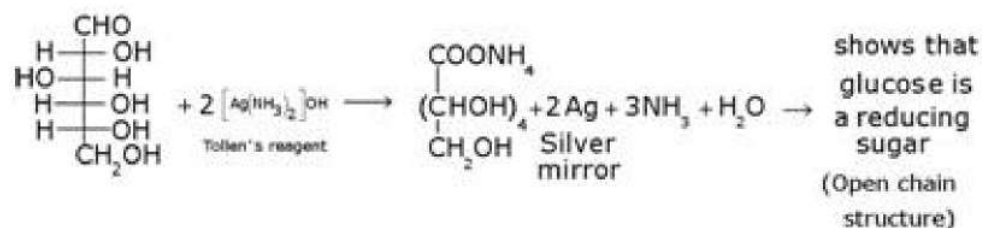

f) D - glucose with nitric acid

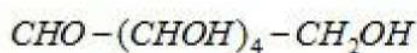

↓
Oxidation

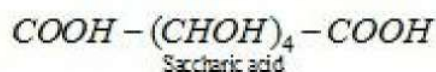

→ This indicates the presence of primary alcoholic group in glucose

↑
Oxidation

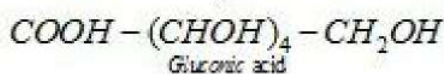

g) D - glucose with $(\text{CH}_3\text{CO})_2\text{O}$ and ZnCl_2

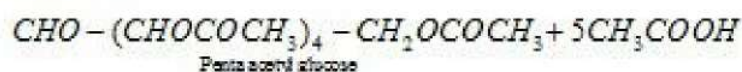

→

shows the presence of 5 -OH groups

h) D - glucose with bromine water

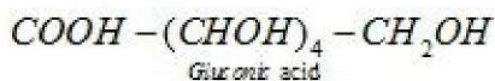

i) Glucose with phenyl hydrazine to form osazone

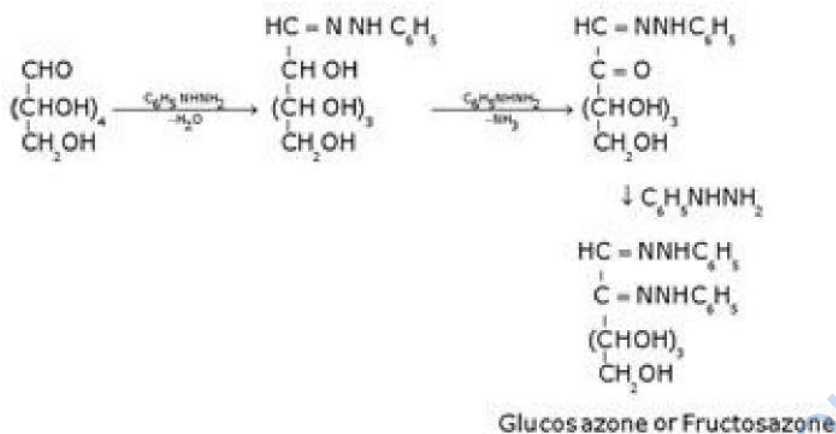

Glucose and fructose gives the same osazone because the reaction takes place at C1 and C2 only.

- Other Reactions of Glucose (Presence of ring structure)**

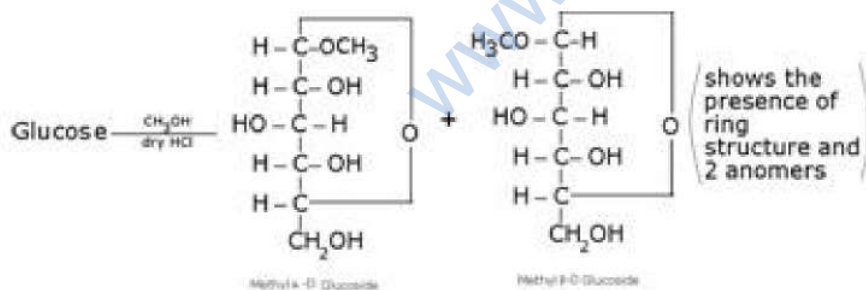

Glucose does not give Schiff's test and does not react with sodium bisulphite and NH₃. Pentaacetyl glucose does not react with hydroxyl amine. This shows the absence of -CHO group and hence the presence of ring structure.

- Cyclic structure of glucose:**

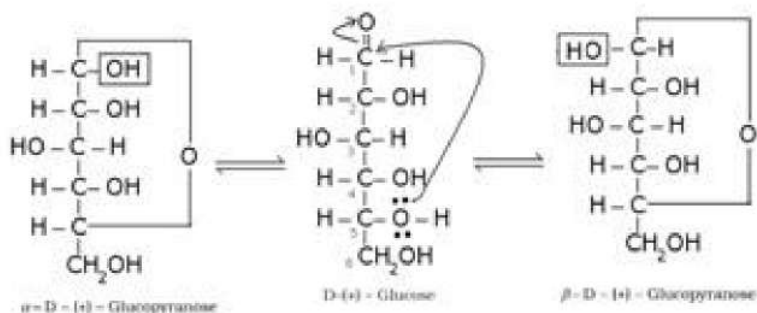

- **Haworth representation of glucose:**

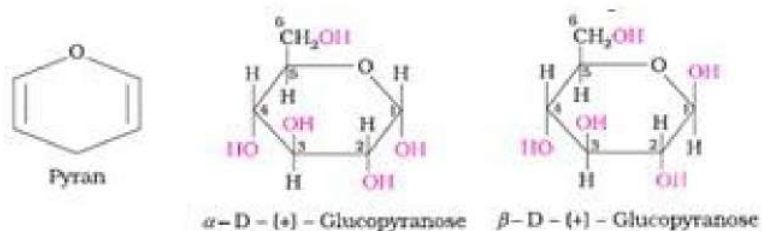

- **Cyclic structure of fructose:**

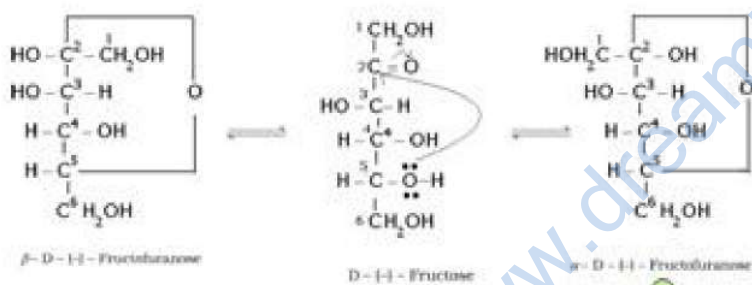

- **Haworth representation of fructose**

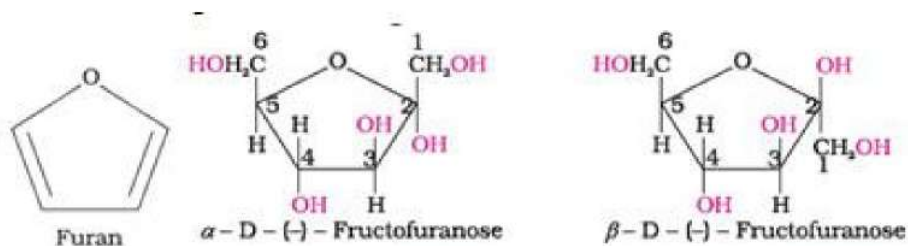

- **Glycosidic linkage:** The oxide linkage formed by the loss of a water molecule when two monosaccharides are joined together through oxygen atom is called glycosidic linkage.

- **Sucrose (invert sugar):**

a) Sucrose is a non-reducing sugar because the two monosaccharide units are held together by a glycosidic linkage between C1 of α -glucose and C2 of β -fructose. Since the reducing groups of glucose and fructose are involved in glycosidic bond formation, sucrose is a non-reducing sugar.

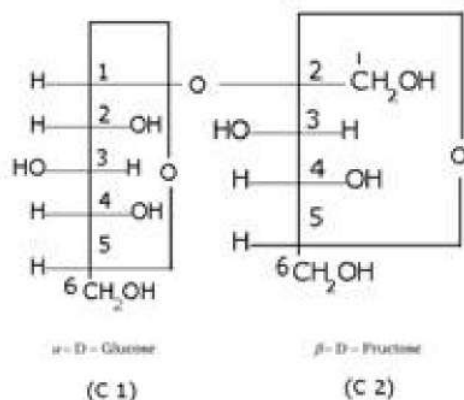

b) Sucrose is dextrorotatory but on hydrolysis it gives dextrorotatory & laevorotatory and the mixture is laevorotatory.

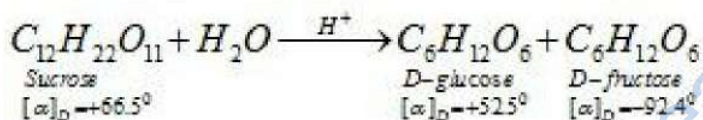

• **Haworth Projection of Sucrose:**

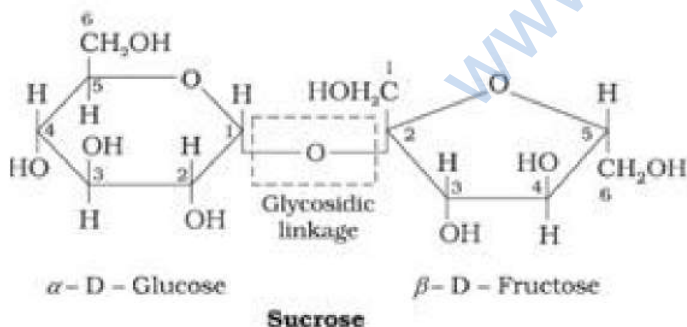

• **Maltose:**

1. Maltose is composed of two α -D-glucose units in which C1 of one glucose (I) is linked to C4 of another glucose unit (II).
2. The free aldehyde group can be produced at C1 of second glucose in solution and it shows reducing properties so it is a reducing sugar.

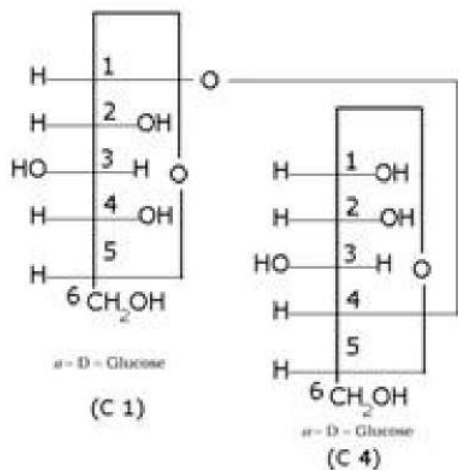
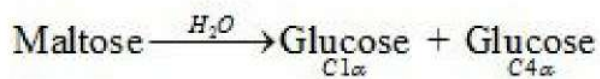

- Haworth projection of maltose:

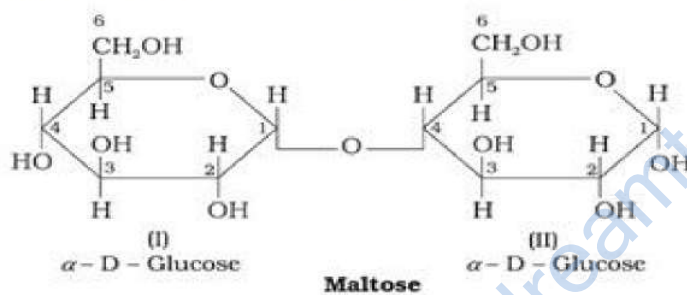

- **Lactose (Milk sugar):** It is composed of β -D-galactose and β -D-glucose. The linkage is between C1 of galactose and C4 of glucose. Hence it is also a reducing sugar.

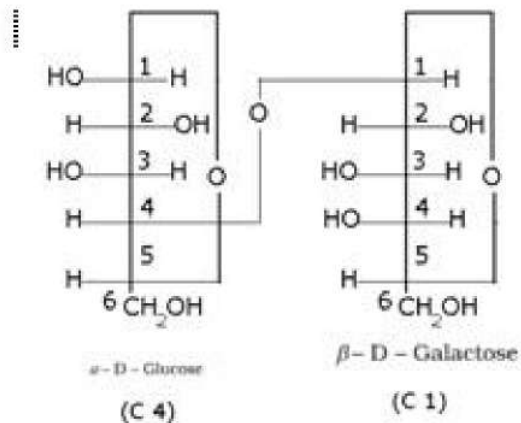
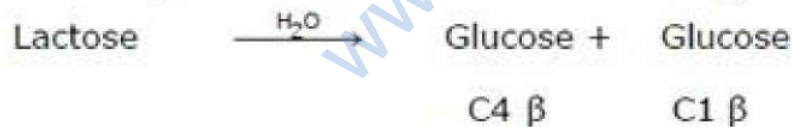

- Haworth projection of lactose:

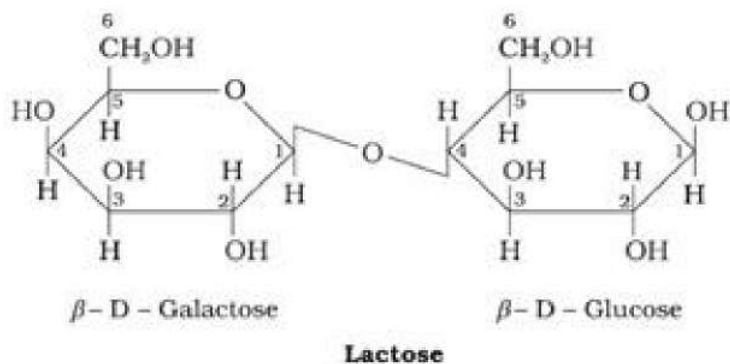

- **Starch:** It is a polymer of α -glucose and consists of two components — Amylose and Amylopectin.

- **Amylose:**

1. It is a water soluble component
2. It is a long unbranched chain polymer
3. It contains 200 – 1000 α -D-(+)- glucose units held by α - glycosidic linkages involving C1 – C4 glycosidic linkage
4. It constitutes about 15-20% of starch

- **Amylopectin**

1. It is a water insoluble component
2. It is branched chain polymer
3. It forms chain by C1 – C4 glycosidic linkage whereas branching occurs by C1 – C6 glycosidic linkage
4. It constitutes about 80-85% of starch

- **Cellulose:**

1. It occurs exclusively in plants.
2. It is a straight chain polysaccharide composed only of β -D-glucose units which are joined by glycosidic linkage between C1 of one glucose unit and C4 of the next glucose unit.

- **Glycogen:**

1. The carbohydrates are stored in animal body as glycogen.

- It is also known as animal starch because its structure is similar to Amylopectin.
- It is present in liver, muscles and brain.
- When the body needs glucose, enzymes break the glycogen down to glucose.

- Amino acids:**

Amino acids contain amino ($-NH_2$) and carboxyl ($-COOH$) functional groups.

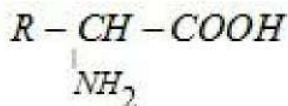

Where R – Any side chain

Most naturally occurring amino acids have L – Config.

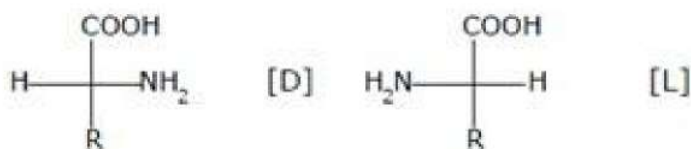

- Types of amino acids:**

a). **Essential amino acids:** The amino acids which cannot be synthesised in the body and must be obtained through diet, are known as essential amino acids. Examples: Valine, Leucine

b). **Non-essential amino acids:** The amino acids, which can be synthesised in the body, are known as non-essential amino acids. Examples: Glycine, Alanine

- Zwitter ion form of amino acids:**

- Amino acids behave like salts rather than simple amines or carboxylic acids. This behaviour is due to the presence of both acidic (carboxyl group) and basic (amino group) groups in the same molecule. In aqueous solution, the carboxyl group can lose a proton and amino group can accept a proton, giving rise to a dipolar ion known as zwitter ion. This is neutral but contains both positive and negative charges.
- In zwitter ionic form, amino acids show amphoteric behaviour as they react both with acids and bases.

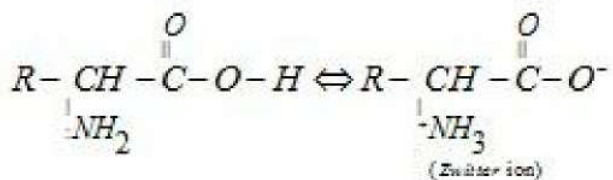

- **Isoelectric point:** The pH at which the dipolar ion exists as neutral ion and does not migrate to either electrode cathode or anode is called isoelectric point.
- **Proteins:** Proteins are the polymers of α -amino acids and they are connected to each other by peptide bond or peptide linkage. A polypeptide with more than hundred amino acid residues, having molecular mass higher than 10,000u is called a protein.
- **Peptide linkage:** Peptide linkage is an amide linkage formed by condensation reaction between $-\text{COOH}$ group of one amino acid and $-\text{NH}_2$ group of another amino acid.

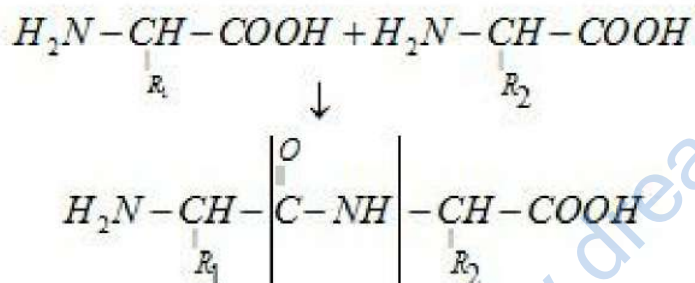

Peptide linkage

- **Primary structure of proteins:** The sequence of amino acids is said to be the primary structure of a protein.
- **Secondary structure of proteins:** It refers to the shape in which long polypeptide chain can exist. Two different types of structures:

α - Helix:

1. It was given by Linus Pauling in 1951
2. It exists when R- group is large.
3. Right handed screw with the NH group of each amino acid residue H - bonded to $-\text{C} = \text{O}$ of adjacent turn of the helix.
4. Also known as 3.613 helix since each turn of the helix has approximately 3.6 amino acids

and a 13 – membered ring is formed by H – bonding.

5. C = O and N – H group of the peptide bonds are trans to each other.
6. Ramchandran angles (Φ and Ψ) - Φ angle which C_α makes with N – H and Ψ angle which C_α makes with C = O.

β -pleated sheet:

1. It exists when R group is small.
2. In this conformation, all peptide chains are stretched out to nearly maximum extension and then laid side by side which are held together by hydrogen bonds.

- **Tertiary structure of proteins:** It represents the overall folding of the polypeptide chain i.e., further folding of the 2° structure.

- **Types of bonding which stabilize the 3° structure:**

1. Disulphide bridge (-S – S-)
2. H – bonding – (C = O ... H – N)
3. Salt bridge (COO⁻ ... + NH₃)
4. Hydrophobic interactions
5. van der Waals forces

- **Two shapes of proteins:**

Fibrous proteins

- a) When the polypeptide chains run parallel and are held together by hydrogen and disulphide bonds, then fibre– like structure is formed.
- b) These proteins are generally insoluble in water
- c) Examples: keratin (present in hair, wool, silk) and myosin (present in muscles), etc

Globular proteins

- a) This structure results when the chains of polypeptides coil around to give a spherical shape.
- b) These are usually soluble in water.
- c) Examples: Insulin and albumins

- **Quaternary structure of proteins:**

1. Some of the proteins are composed of two or more polypeptide chains referred to as subunits.
2. The spatial arrangement of these subunits with respect to each other is known as quaternary structure of proteins.

- **Denaturation of proteins:**

1. The loss of biological activity of proteins when a protein in its native form, is subjected to physical change like change in temperature or chemical change like change in pH. This is called denaturation of protein.
2. Example: coagulation of egg white on boiling, curdling of milk.

- **Nucleoside:**

1. Base + sugar

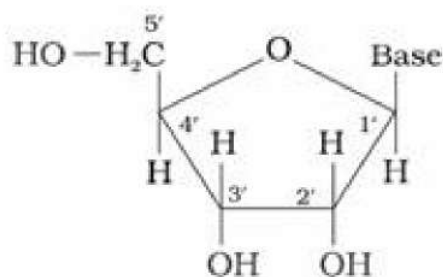

- **Nucleotide:**

1. Base + sugar + phosphate group

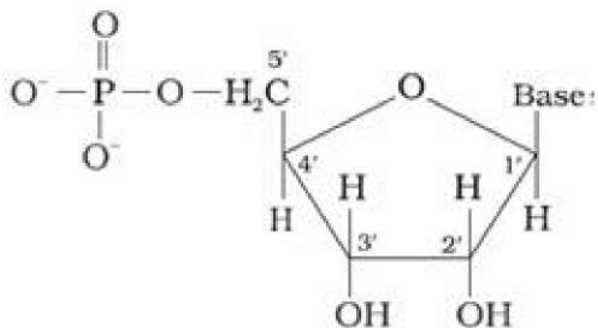

- **Nucleic acids (or polynucleotides):**

-
1. Long chain polymers of nucleotides.
 2. Nucleotides are joined by phosphodiester linkage between 5' and 3' C atoms of a pentose sugar.

- **Two types of nucleic acids:**

DNA

1. It has a double stranded α -helix structure in which two strands are coiled spirally in opposite directions.
2. Sugar present is β -D-2-deoxyribose
3. Bases:
 - i) Purine bases: Adenine (A) and Guanine (G)
 - ii) Pyrimidine bases: Thymine (T) and cytosine (C)
4. It occurs mainly in the nucleus of the cell.
5. It is responsible for transmission for heredity character.

RNA

1. It has a single stranded α -helix structure.
2. Sugar present is β -D-ribose
3. Bases:
 - i) Purine bases: Adenine (A) and Guanine (G)
 - ii) Pyrimidine bases: Uracil (U) and cytosine (C)
4. It occurs mainly in the cytoplasm of the cell.
5. It helps in protein synthesis.

- **Double helix structure of DNA:**

1. It is composed of two right handed helical polynucleotide chains coiled spirally in opposite directions around the same central axis.
2. Two strands are anti-parallel i.e., their phosphodiester linkage runs in opposite directions.
3. Bases are stacked inside the helix in planes \perp to the helical axis.
4. Two strands are held together by H – bonds (A = T, G \equiv C).
5. The two strands are complementary to each other because the hydrogen bonds are

formed between specific pairs of bases.

6. Adenine forms hydrogen bonds with thymine whereas cytosine forms hydrogen bonds with guanine.
7. Diameter of double helix is 2 nm.
8. Double helix repeats at intervals of 3.4 nm. (One complete turn)
9. Total amount of purine (A + G) = Total amount of pyrimidine (C + T)

- **Vitamins:** Vitamins are organic compounds required in the diet in small amounts to perform specific biological functions for normal maintenance of optimum growth and health of the organism.
- **Classification of vitamins:** Vitamins are classified into two groups depending upon their solubility in water or fat.

1. Water soluble vitamins

- i) These vitamins are soluble in water.
- ii) Water soluble vitamins must be supplied regularly in diet because they are readily excreted in urine and cannot be stored (except vitamin B12) in our body.
- iii) Example: Vitamin C, B group vitamins.

2. Fat soluble vitamins

- i) These vitamins are soluble in fat and oils but insoluble in water.
- ii) They are stored in liver and adipose (fat storing) tissues.
- iii) Example: Vitamin A, D, E and K

- **Important vitamins, their sources and their deficiency diseases:**

Name of vitamins	Sources	Deficiency diseases
Vitamin A	Fish liver oil, carrots, butter and milk	xerophthalmia (hardening of cornea of eye) Night blindness

Vitamin B1 (Thiamine)	Yeast, milk, green vegetables and cereals	Beriberi (loss of appetite, retarded growth)
Vitamin B2 (Riboflavin)	Milk, egg white, liver, kidney	Cheilosis (fissuring at corners of mouth and lips), digestive disorders and burning sensation of the skin.
Vitamin B6 (Pyridoxine)	Yeast, milk, egg yolk, cereals and grams	Convulsions
Vitamin B12	Meat, fish, egg and curd	Pernicious anaemia (RBC deficient in haemoglobin)
Vitamin C (Ascorbic acid)	Citrus fruits, amla and green leafy vegetables	Scurvy (bleeding gums)
Vitamin D	Exposure to sunlight, fish and egg yolk	Rickets (bone deformities in children) and osteomalacia (soft bones and joint pain in adults)
Vitamin E	Vegetable oils like wheat germ oil, sunflower oil, etc.	Increased fragility of RBCs and muscular weakness
Vitamin K	Green leafy vegetables	Increased blood clotting time