

# Networking and Open Source Concepts

## TOPIC-1

### Communication Technologies

#### Very Short Answer Type Questions (1 Mark each)

##### Question 1:

Identify the Domain name and URL from the following:

`http://www.income.in/home.aboutus.html`

##### Answer:

Domain name – income.in

URL – `http://www.income.in/home.aboutus.html`.

##### Question 2:

What is web hosting?

##### Answer:

Web hosting is the service that makes our website available to be viewed by others on the Internet. A web host provides space on its server, so that other computers around the world can access our website by means of a network or modem.

##### Question 3:

Write two characteristics of Wi-Fi.

##### Answer:

1. It is wireless network.
2. It is for short range.

##### Question 4:

Which protocol is used to creating a connection with a remote machine?

##### Answer:

**Telnet:** It is an older internet utility that lets us log on to remote computer system. It also facilitates for terminal emulation purpose.

##### Question 5:

Which protocol is used to create a connection to a remote machine? Give any two advantages of using optical fibers.

**Answer:**

Two advantage of using optical fibers are:

1. Capable of extremely high-speed.
2. No electromagnetic interference.
3. Extremely low attending.

**Question 6:**

Expand the following:

1. GSM
2. GPRS

**Answer:**

1. **GSM:** Global System for Mobile Commu-nication.
2. **GPRS:** General Packet Radio Service.

**Question 7:**

What is the difference between packet and message switching ?

**Answer:**

Packet switching	Message switching
There is a tight upper limit on the block size. A fixed size of packet is specified.	In message switching there was no upper limit.
All the packets are stored in main memory in switching office.	In message switching packets are stored on disk. This increases the performance as access time is reduced.

**Question 8:**

What is cloud computing?

**Answer:**

The sharing of compute resources (dedicated, time-shared, or dynamically shared servers) and related infrastructure components (load balncers, firewalls, network

storage, developer tools, monitors and management tools) to facilitate the deployment and operation of web and network based applications. Cloud computing relies on sharing of resources to achieve coherence and economies of scale, similar to a utility (like the electricity grid) over a network.

**Question 9:**

Which type of network (out of LAN, PAN and MAN) is formed, when you connect two mobiles using Bluetooth to transfer a video?

**Answer:**

PAN

**Question 10:**

Write one characteristic each for 2G and 3G mobile technologies.

**Answer:**

2G networks primarily involve the transmission of voice information, 3G technology provides the additional advantage of data transfer.

**Question 11:**

What is the difference between Packet switching and circuit switching techniques?

**Answer:**

In circuit switching, a dedicated path exists from source to destination while in packet switching, there is no fixed path.

**Question 12:**

Write two advantages of using an optical fibre cable over an Ethernet cable to connect two service stations, which are 200 m away from each other.

**Answer:**

Advantages of optical fibre:

1. Faster speed than ethernet
2. Lower attenuation

**Question 13:**

Write one advantage of bus topology of network. Also illustrate how four (4) computers can be connected with each other using bus topology of network.

**Answer:**

Advantage (benefits) of linear Bus topology is that the cable length required for this topology is the least compared to the other networks.

Bus Topology of Network:

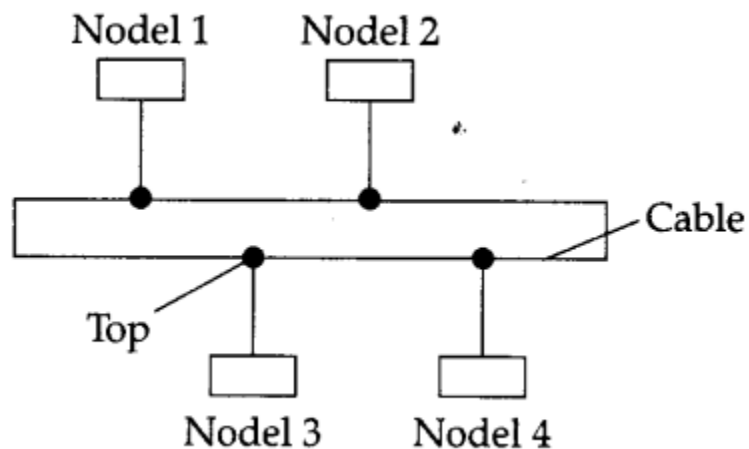

**Question 14:**

Give one suitable example of each URL and Domain Name.

**Answer:**

URL: <http://waltons.in>

Domain Name: @gmail.com

**Question 15:**

Write one advantage of star topology network? Also, illustrate how five (5) computers can be connected to each other using star topology of network.

**Answer:**

Advantage (benefits) of star topology:

www.dreamtopper.in

Easy to replace, install or remove hosts or other devices.

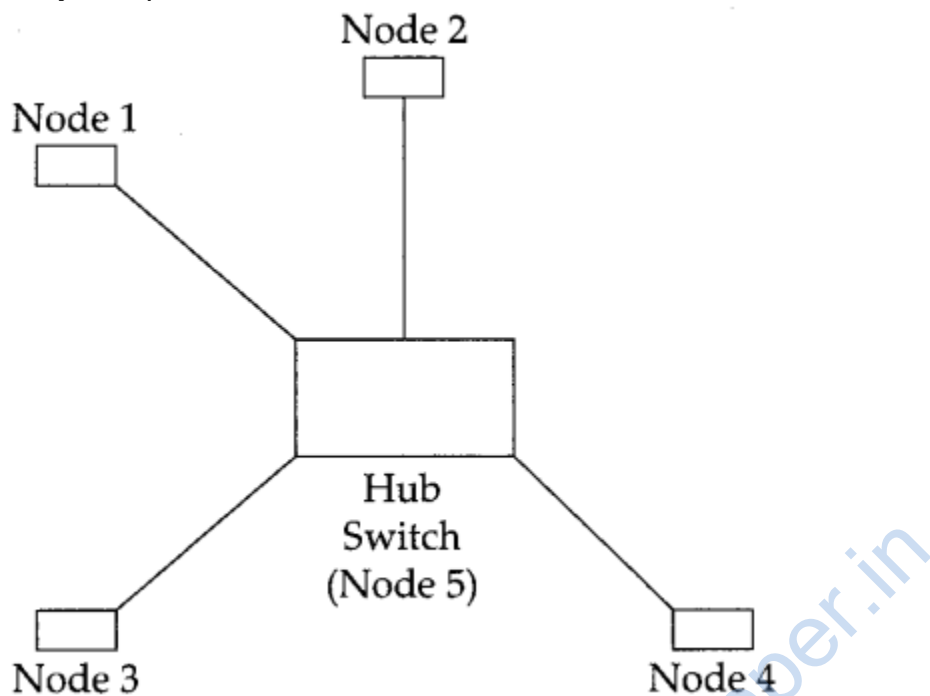

**Question 16:**

What is the function of Modem?

**Answer:**

The function of modem is modulation and demodulation, means turn data into a format that can be transmitted via an audio link such as a phone line.

**Question 17:**

Explain the purpose of a router.

**Answer:**

A router established connection between two networks and it can handle network with different protocols. Using a routing table, routers make sure that the data packets are travelling through the best possible paths to reach their destination.

**Question 18:**

Name any two components required for net-working.

**Answer:**

1. Repeater
2. Routers

**Question 19:**

What are repeaters?

**Answer:**

A repeater is an electronic device that receives a signal and retransmits it at a higher level and/ or higher power, or onto the other side of an obstruction, so that the signal can cover longer distances.

**Question 20:**

Mention one advantage of star topology over bus topology in networking?

**Answer:**

Simple to add more computers to network.

**Question 21:**

Differentiate between packet switching and message switching technique in network communication.

**Answer:**

In packet switched network, data are transmitted in discrete units of potentially variable length blocks called packets, while in message switching mechanism, a node receives a message stores it until the appropriate route is free, then sends it along.

**Question 22:**

Differentiate between Bus and Star topology of network.

**Answer:**

Bus topology		Star topology	
(i)	Bus topology is a linear	(i)	Star topology is non-linear
(ii)	No switch is used	(ii)	Switch is used to connect the computers.

**Question 23:**

What is VoIP?

**Answer:**

Voice over Internet Protocol (VoIP) is one of a family of internet technologies, communication protocols, and transmission technologies for delivery of voice

communications and multi-media sessions over internet protocol (IP) network, such as the internet.

**Question 24:**

In networking, what is WAN? How is it different from LAN?

**Answer:**

**WAN (Wide Area Network):**

A communication network that uses such devices as telephone lines, satellite, dishes, or radiowaves to span a larger geographic area which cannot be covered by a LAN.

**Question 25:**

Define the term bandwidth. Give any one unit of bandwidth.

**Answer:**

Bandwidth is referred as the volume of information per unit of time that a transmission medium (like an internet connection) can handle.

**OR**

The amount of data that can be transmitted in a fixed amount of time is known as bandwidth. For digital devices, the bandwidth is usually expressed in bits per second (bps) or bytes per second. For analog devices, the bandwidth is expressed in cycles per second, or Hertz (Hz).

**Question 26:**

What is the difference between LAN and MAN?

**Answer:**

**LAN:** It is Local Area Network. The diameter is not more than a single building.

**WAN:** It is Metropolitan Area Network. LAN spans a few kms while MAN spans 5-50 km diameter and is larger than a LAN.

**Question 27:**

What is the importance of URL in networking ?

**Answer:**

A Uniform Resource Locator (URL) is used to specify, where an identified resource is available in the network and the mechanism for retrieving it. A URL is also referred to as a web address. 1

**Question 28:**

What was the role of ARPANET in the computer network?

**Answer:**

In 1969, ARPANET was set up by the American government for defence purpose. ARPANET stands for Advanced research Projects agency Network.

**Question 29:**

Which of the following is not a unit for data transfer rate ?

1. bps
2. abps
3. gbps
4. kbps

**Answer:**

(ii) abps

**Question 30:**

Identify the type of topology from the following:

1. Each node is connected with the help of a single cable
2. Each node is connected with the help of independent cable with central switching.

**Answer:**

1. Bus topology
2. Star topology

**Question 31:**

ABC International School is planning to connect all computers, each spread over a distance of 50 metres. Suggest an economic cable type having high speed data transfer to connect these computers.

**Answer:**

Optical fibre cable.

**Question 32:**

Mahesh wants to transfer data within a city at very high speed. Write the wired transmission medium and type of network.

**Answer:**

Wired transmission medium – Optical fibre cable Type of network – MAN.

**Question 33:**

Which device is used to connect all computers inside a lab?

**Answer:**

Hub



**Question 34:**

Which device is used to connect all computers to the internet using telephone wire?

**Answer:**

RJ – 45. It is an eight wired connectors used to connect computers on a LAN.

**Question 35:**

What is Wi-Fi Card?

**Answer:**

Wi-Fi cards are small and portable cards that allow the computer to connect to the internet through a wireless network. The transmission is through the use of radio waves.

**Short Answer Type Questions**

**Question 1:**

Write any two differences between twisted pair and co-axial pair cable.

**Answer:**

Twisted Pair	Co-axial Cable
Their bandwidth is not as high as co-axial cables.	It has high bandwidth.
A twisted pair consists of two copper wires twisted around each other (each has its own insulation around it) like a double helix.	A co-axial cable consists of a copper wire core covered by an insulating material and a layer of conducting material over that.

**Question 2:**

Write one advantage of Bus Topology of network, also, illustrate how 4 computers can be connected with each other using star topology of network.

**Answer:**

**Bus topology:** Cable length required for his topology is the least compared to other

networks.

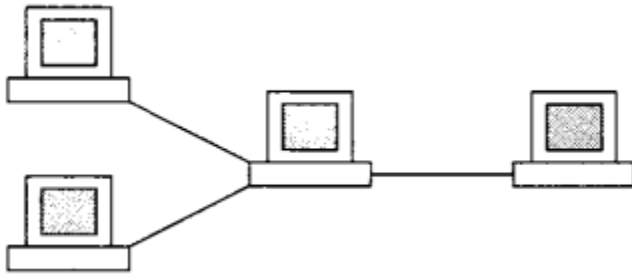

### Question 3:

Explain any two switching techniques used in networking.

### Answer:

**Message Switching:** It is similar to Post-office mailing system. A temporary link is established for one message transfer.

**Packet Switching:** It is a form of store and forward switching system which stores the message as small packets at the switch nodes and then transmits it to the destination.

## Long Answer Type Questions

### Question 1:

Write answer of the following:

- Differentiate between PAN and LAN types of networks.
- Which protocol helps us to transfer files to and from a remote computer ?
- Write two advantages of 3G over 2G mobile telecommunication technologies in terms of speed and services.
- Write two characteristics of Web 2.0
- Write the basic difference between worm and Trojan Horse.
- Categorize the following under client-side and server-side scripts category:

- Java Script
- ASP
- VB Script
- JSP

(g) Intelligent Hub India is a knowledge community aimed to uplift the standard of skills and knowledge in the society. It is planning to setup its training centres in multiple towns and villages pan India with its head offices in the nearest cities. They have created a model of their network with a city, a town and 3 villages as given.

As a network consultant, you have to suggest the best network related solution for their issues/problems raised

in (i) to (iv) keeping in mind the distance between various locations and given

parameters.

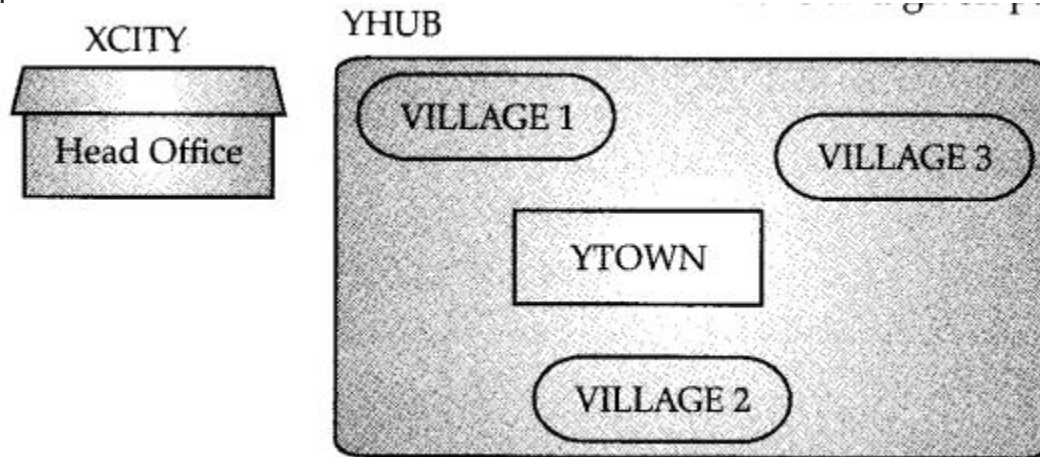

Shortest distance between various locations:

VILLAGE 1 To YTOWN	2 KM
VILLAGE 2 To YTOWN	1.2 KM
VILLAGE 3 To YTOWN	3 KM
VILLAGE 1 To VILLAGE 2	3.5 KM
VILLAGE 1 To VILLAGE 3	4.5 KM
VILLAGE 2 To VILLAGE 3	3.5 KM
CITY Head office to YHUB	30 KM

Number of computers installed at various locations are as follows:

YTOWN	100
VILLAGE 1	10
VILLAGE 2	15
VILLAGE 3	15
CITY OFFICE	5

**Note:**

- In Villages, there are community centres, in which one room has been given as

training center to this organization to install computers.

- The organization has got financial support from the government and top IT companies.

1. Suggest the most appropriate location of the SERVER in the YHUB (out of the 4 locations), to get the best and effective connectivity. Justify your answer.
2. Suggest the best wired medium and draw the cable layout (location to location) to efficiently connect various locations within the YHUB.
3. Which hardware device will you suggest to connect all the computers within each location of YHUB?
4. Which server/protocol will be most helpful to conduct live interaction of Experts from Head office and people at YHUB locations?

**Answer:**

1.(a)

PAN (Personal Area Network)	LAN (Local Area Network)
A personal area network-PAN-is a computer network organized around an individual person.	LAN interconnects a high numbers of access or node points or stations within a confined physical area upto a kilometer.

**OR**

(b) FTP or Telnet or TCP

**FTP OR Telnet OR TCP**

(c) Speed

1. Faster web browsing.
2. Faster file transfer  
Service –
3. Better video clarity
4. Better security

**OR**

**(Any other correct advantage can be considered)**

(d) Makes web more interactive through online social media.

Supports easy online information exchange.

Interoperability on the internet.

Video sharing possible in the websites.

(e)

Trojan Horse	Computer Worm
It is a "Malware" computer program presented as useful or harmless in order to induce the user to install and run them.	It is a self-replicating computer program which uses a network to send copies of itself to other computers on the network and it may do so without any user intervention.

(f)

Client Side Scripts	Server Side Scripts
VB Script	ASP
Java Script	JSP

(g)(i) YTOWN

Justification

1. Since it has the maximum number of computers.
2. It is closet to all other locatios.

(ii) Optical Fiber

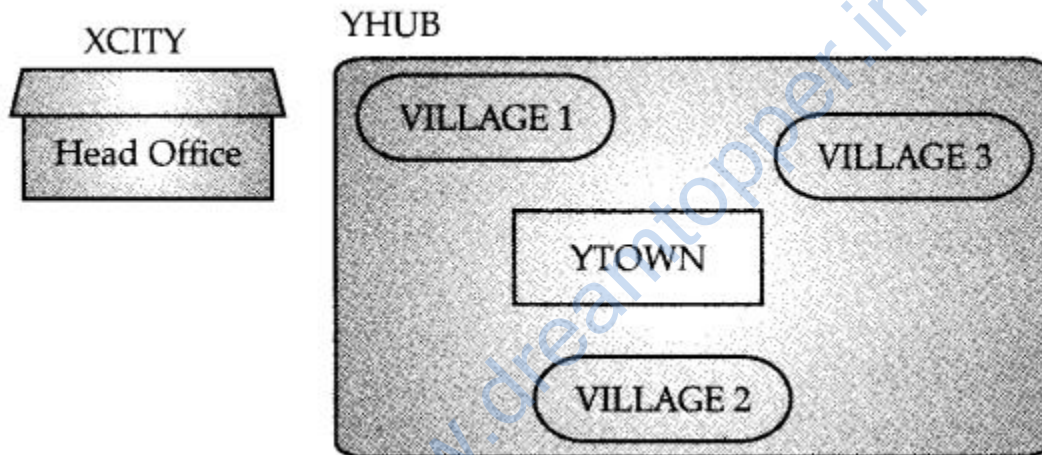

(iii) Switch or Hub

(iv) Video conferencing or VoIP or any other correct service/protocol.

**Question 2:**

Indian School, in Mumbai is starting up the network between its different wings. There are four Buildings named as SENIOR, JUNIOR, ADMIN and HOSTEL as shown below:

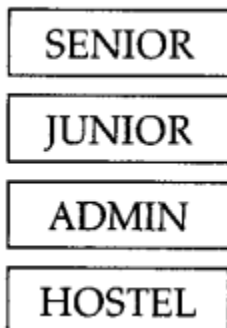

The distance between various buildings is as follows:

ADMIN TO SENIOR	200m
ADMIN TO JUNIOR	150m
ADMIN TO HOSTEL	50m
SENIOR TO JUNIOR	250m
SENIOR TO HOSTEL	350m
JUNIOR TO HOSTEL	350m

Number of Computers in Each Building :

SENIOR	130
JUNIOR	80
ADMIN	160
HOSTEL	50

1. Suggest the cable layout of connections between the buildings.
2. Suggest the most suitable place (i.e., building) to house the server of this school, provide a suitable reason.
3. Suggest the placement of the following devices with justification.
  - Repeater
  - Hub/Switch
4. The organisation also has inquiry office in another city about 50-60 km away in hilly region. Suggest the suitable transmission media to interconnect to school and inquiry office out of the following :
  - Fiber optic cable
  - Microwave
  - Radiowave

**Answer:**

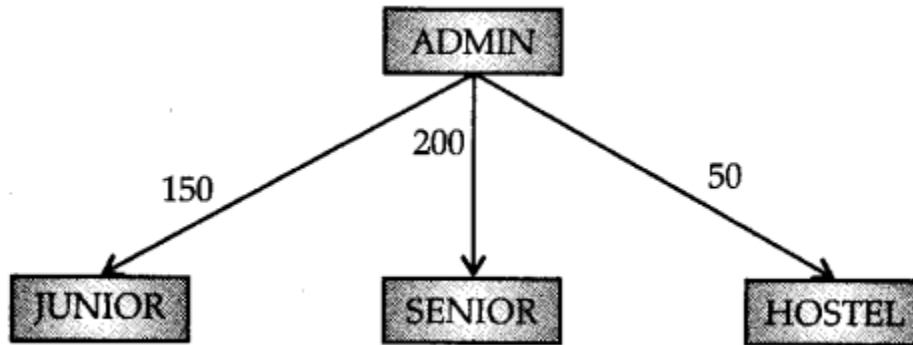

- 1.
2. Server can be placed in the ADMIN building as it has the maximum number of computer.
3. Repeater can be placed between ADMIN and SENIOR building as the distance is more than 110 m.
4. Radiowaves can be used in hilly regions as they can travel through obstacles.

**Question 3:**

Vidya Senior Secondary Public School in Nainital is setting up the network between its different wings. There are 4 wings named as SENIOR(S), JUNIOR(J), ADMIN(A) and HOSTEL(H).

Distance between various wings are given below:

Wing A to Wing S	100 m
Wing A to Wing J	200 m
Wing A to Wing H	400 m
Wing S to Wing J	300 m
Wing S to Wing H	100 m
Wing J to Wing H	450 m

Wing	Number of Computers
Wing A	20
Wing S	150
Wing J	50
Wing H	25

1. Suggest a suitable Topology for networking the computers of all wings.
2. Name the most suitable wing where the Server should be installed. Justify your answer.

3. Suggest where all should Hub(s)/Switch(es) be placed in the network.
4. Which communication medium would you suggest to connect this school with its main branch in Delhi ?

**Answer:**

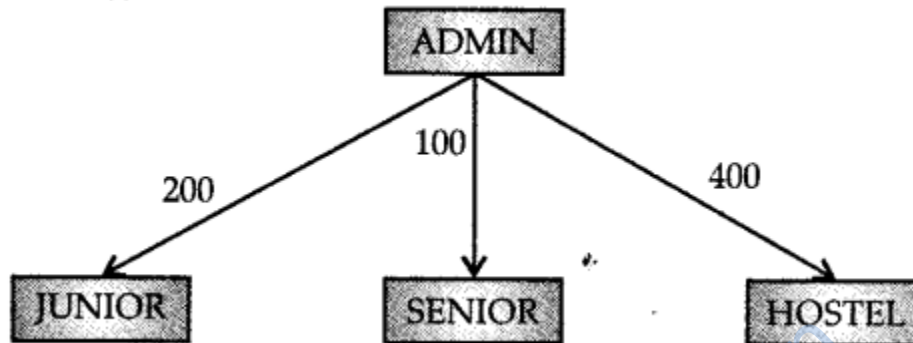

- 1.
2. Server should be in Wing S as it has the maximum number of computers. 1
3. All Wings need hub/switch as it has more than one computer.
4. Since the distance is more, wireless transmission would be better. Radiowaves are reliable and can travel through obstacles.

**Question 5:**

1. Which out of three type of networks LAN, MAN and WAN, is to be used when an institute connects computers of two adjacent computer laboratories ?
2. What is the difference between HTTP and FTP?
3. What is the major difference between Message Switching and Packet Switching in networking?
4. What is the basic difference between DNS and URL?
5. Give two applications of web 2.0.
6. Categories the following under client side and Server-Side script category?
  - JSP
  - ASP
  - VBScript
  - Java Script

**Answer:**

- (i) LAN (The range is upto one KM)
- (ii)



HTTP	FTP
<ul style="list-style-type: none"> <li>● Stands for Hyper Text Transfer protocol</li> <li>● It is used to transfer web pages on www.</li> </ul>	<ul style="list-style-type: none"> <li>● It stands for file transfer protocol.</li> <li>● It is used to write data over server.</li> </ul>

(iii)

Message Switching	Packet Switching
<ul style="list-style-type: none"> <li>(i) It communicate among two proceses</li> <li>(ii) physical links are allocated dynamicly</li> </ul>	<ul style="list-style-type: none"> <li>(i) It share the data in many computers</li> <li>(ii) Virtual links are made simultanously.</li> </ul>

(iv)

DNS	URL
<ul style="list-style-type: none"> <li>● It stands for Domain Name Server.</li> <li>● It is the Avitar or webId for any person website over internet.</li> </ul>	<ul style="list-style-type: none"> <li>● It stands for Universal Resource locator.</li> <li>● It is the unique IP address provided to any group, person or company.</li> </ul>

(v) Application of web 2.0

1. web hosting
2. web browsing
3. web Indexing
4. web searching

(vi) Client side Script

1. JSP
  2. Java Script
- Server Side Scripts

3. ASP
4. VB Script

**Question 6:**

Trine Tech Corporation (TTC) is a professional consultancy company. The company is planning to set up their new offices in India with its hub at Hyderabad. As a network adviser, you have to understand their requirement and suggest them the best available solutions. Their queries are mentioned as (i) to (iv) below.

**Physical Locations of the blocked of TTC**

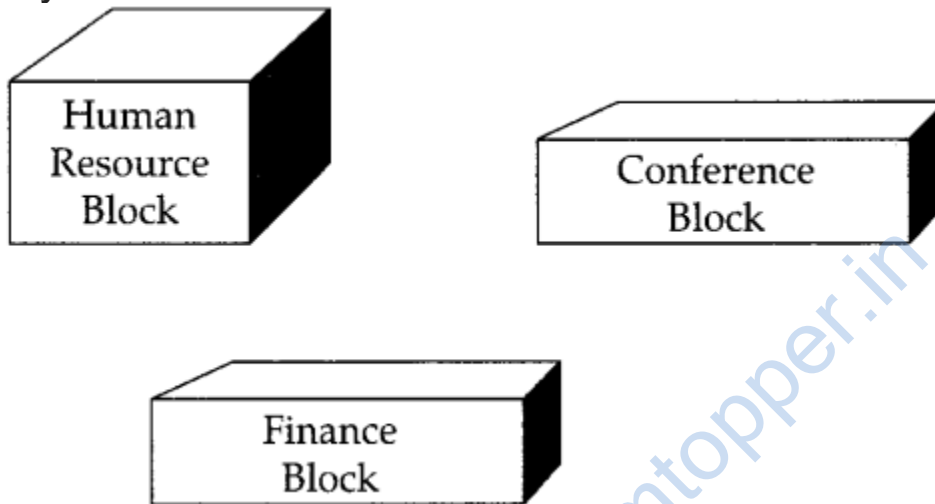

**Block to Block distances (in Mtrs.)**

Block (From)	Block (To)	Distance
Human Resource	Conference	110
Human Resource	Finance	40
Conference	Finance	80

**Expected number of computers to be installed in each block.**

Block	Computers
Human Resource	25
Finance	120
Conference	90

1. What will be the most appropriate block, where TTC should plan to install their server?
2. Draw a block to cable layout to connect all the buildings in the most appropriate manner for efficient communication.

3. What will be the best possible connectivity out of the following, you will suggest to connect the new setup of offices in Bangalore with its London based office:
  - Satellite Link
  - Infrared
  - Ethernet Cable
4. Which of the following device will be suggested by you to connect each computer in each of the buildings:
  - Switch
  - Modem
  - Gateway

**Answer:**

1. Finance block because it has maximum number of computers.

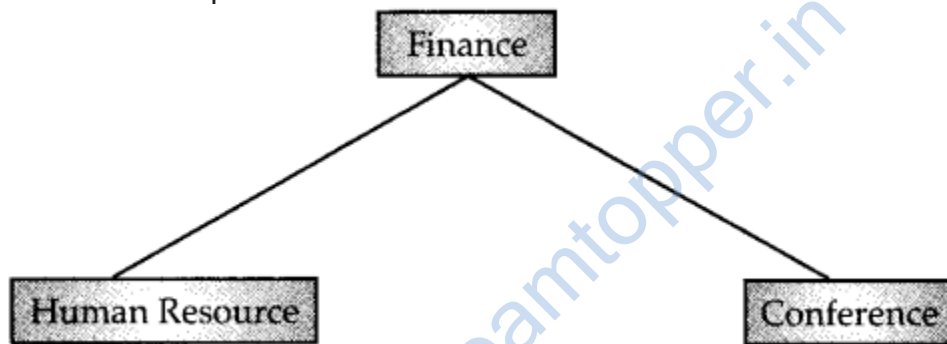

- 2.
3. Satellite link
4. Switch

**Question 7:**

G.R.K International Inc. is planning to connect its Bengaluru Office Setup with its Head Office in Delhi. The Bengaluru Office G.R.K. international Inc. is spread across an area of approx. 1 square kilometer, consisting of 3 blocks – Human Resources, Academics and Administration.

You as a network expert have to suggest answers to the four queries (i) to (iv) raised by them.

Notes : Keep the distance between blocks and number of computers in each block in mind, while providing them the solutions.

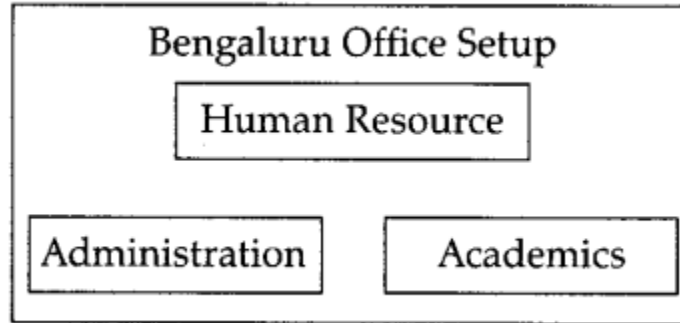

**Shortest distances between various blocks:**

Human Resources to Administration	100 m
Human Resources to Academics	65 m
Academics to Administration	110 m
Delhi Head Office to Bengaluru Office Setup	2350 km

**Number of computers installed at various blocks are as follows:**

BLOCK	No. of Computers
Human Resources	155
Administration	20
Academics	100
Delhi Head Office	20

1. Suggest the most suitable block in the Bengaluru Office Setup, to host the server. Give a suitable reason with your suggestion.
2. Suggest the cable layout among the various blocks within the Bengaluru Office Setup for connecting the Blocks.
3. Suggest a suitable networking device to be installed in each of the blocks essentially required for connecting computers inside the blocks with fast and efficient connectivity.
4. Suggest the most suitable media to provide secure, fast and reliable data connectivity between Delhi Head Office and the Bengaluru Office Setup.

**Answer:**

1. Human Resources because it has maximum number of computers.

(ii)

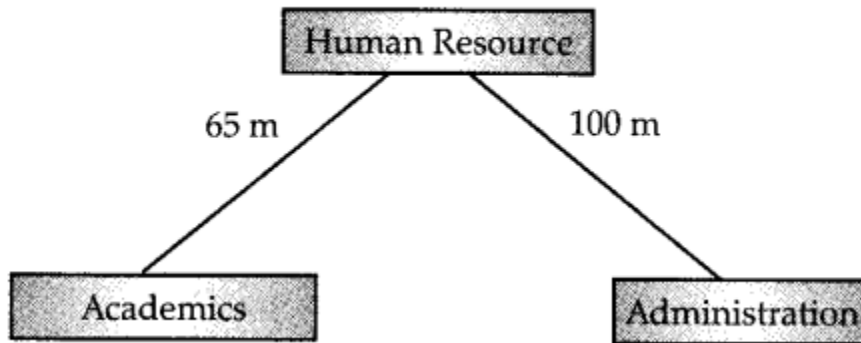

- 2.
3. Switch 1
4. Satellite link

**Question 8:**

Rovenza Communications International (RCI) is an online corporate training provider company for IT related courses. The company is setting up their new campus in Kolkata. You as a network expert have to study the physical locations of various blocks and the number of computers to be installed. In the planning phase, provide the best possible answers for the queries (i) to (iv) raised by them.

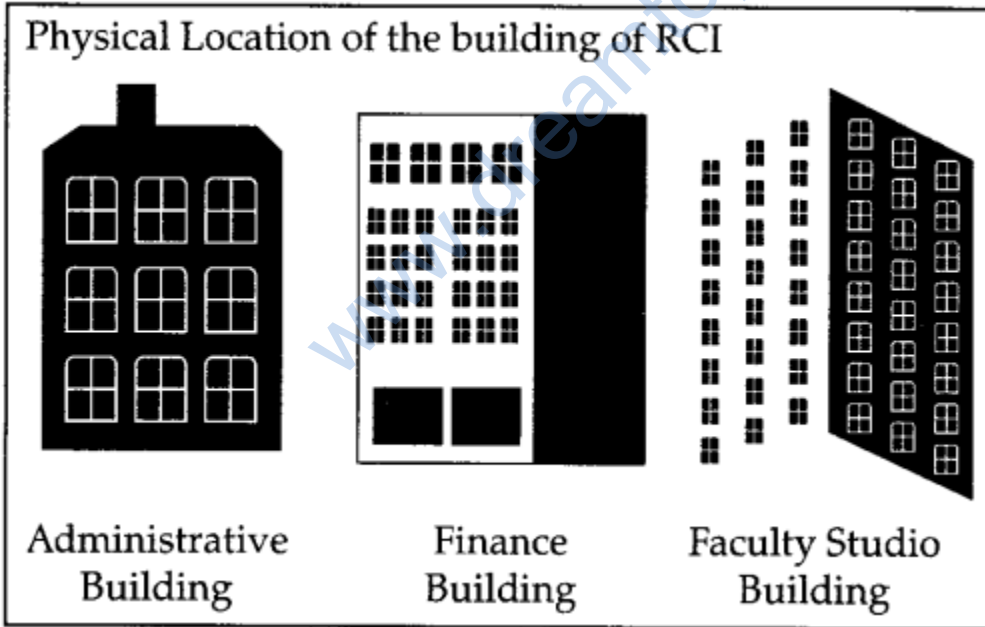

Block to Block Distances(in Mtrs.)

From	To	Distance
Administrative Building	Finance Building	60
Administrative Building	Faculty Studio Building	120
Finance Building	Faculty Studio Building	70

Expected computers to be installed in each block

Buildings	Computers
Administrative Building	20
Finance Building	40
Faculty Studio Building	120

- Suggest the most appropriate block, where RCI should plan to install the server.
- Suggest the most appropriate block to block cable layout to connect all three blocks for efficient communication.
- Which type of network out of the following is formed by connecting the computers of these three blocks?
  - LAN
  - MAN
  - WAN
- Which wireless channel out of the following should be opted by RCI to connect to students from all over the world?
  - Infrared
  - Microwave
  - Satellite
- Write two advantages of using open source software over proprietary software.
- Which of the following crime(s) does not come under cybercrime?
  - Copying some important data from a computer without taking permission from the owner of-the data.
  - Stealing keyboard and mouse from a shop.
  - Getting into unknown person's social networking account and start messaging on his behalf.

**Answer:**

- Faculty Recording Block.
- Star topology

3. LAN
4. Satellite connection
5. Advantages of open source over proprietary software:
  - Open source software's source code is available, can be modified copied & distributed while proprietary software can't be change.
  - Open source is free while proprietary a paid.
6. (c) Stealing keyboard & mouse from a shop.4

**Question 9:**

1. Identify the type of topology on the basis of the following:
  - Since every node is directly connected to the server, a large amount of cable is needed which increases the installation cost of the network.
  - It has a single common data path connecting all the nodes.

**Answer:**

1. Star Topology
2. Bus Topology

(ii) Expand the following

1. VOIP
2. SMTP

**Answer:**

1. Voice Over Internet Protocol
2. Simple Mail Transder Protocol

(iii) Who is a hacker?

**Answer:**

A computer enthusiast, who uses his computer programming skill to intentionally access a computer without authorization is known as hacker. A hacker accesses the computer without the intention of destroying data or maliciously harming the computer.

(iv) The following is a 32 bit binary number usually represented as 4 decimal values, each representing 8 bits, in the range 0 to 255 (known as octets) separated by decimal points. 140.179.220.200

What is it? What is its importance?

**Answer:**

It is an IP Address. It is used to identify the computers on a network.

(v) Daniel has to share the data among various computes of his two offices branches

situated in the same city. Name the network (out of LAN, WAN, PAN and MAN) which is being formed in this process.

**Answer:**

MAN

(vi) Rehaana Medicos Center has set up its new center in Dubai. It has four buildings as shown in the diagram given below:

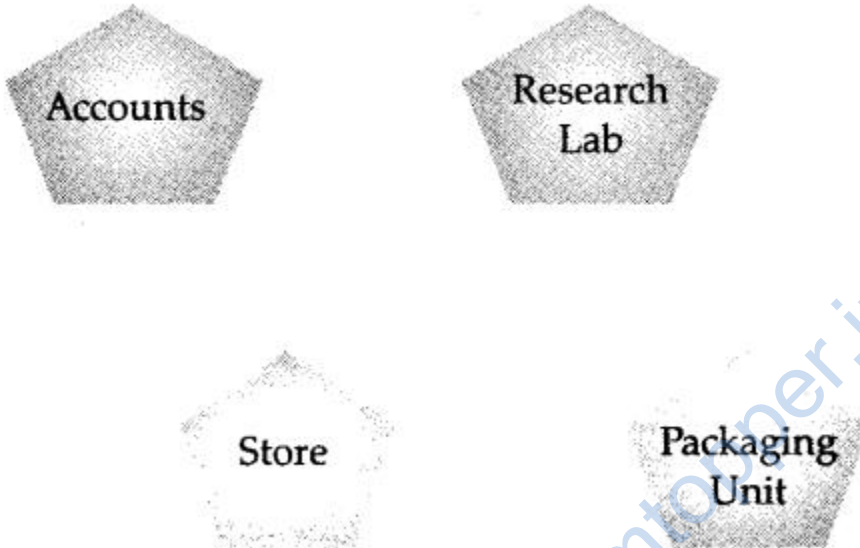

Distances between various buildings are as follows :

Accounts to Research Lab	55 m
Accounts to Store	150 m
Store to Packaging Unit	160 m
Packaging Unit to Research Lab	60 m
Accounts to Packging Unit	125 m
Store to Research Lab	180 m

**Number of Computers:**

Accounts	25
Reserach Lab	100
Store	15
Packging Unit	60



As a network expert, provide the best possible answer for the following queries:

1. Suggest a cable layout of connections between the buildings.
2. Suggest the most suitable place (i.e. building) to house the server of this organization.
3. Suggest the placement of the following device with justification:
4. Repeater (b) Hub/Switch
5. Suggest a system (hardware/software) to prevent unauthorized access to or from the network.

**Answer:**

1. Layout 1
2. The most suitable place / building to house the server of this organization would be building Research Lab, as this building contains the maximum number of computers.
3. Since the cabling distance between Accounts to Store is quite large, so a repeater would ideally be needed along their path to avoid loss of signals during the course of data flow in this route.
4. Firewall.

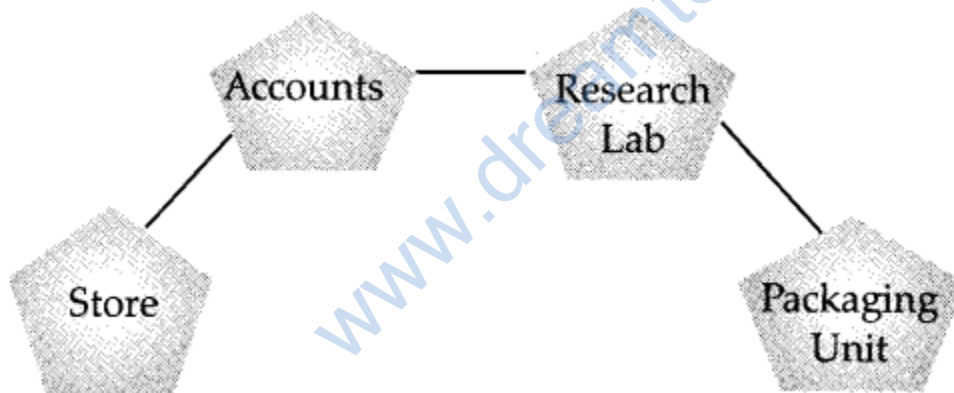

**Question 10:**

1. What is the difference between domain name and IP address?
2. Write two advantages of using an optical fibre cable over an Ethernet cable to connect two service stations, which are 190 m away from each other.
3. Expertfa Professional Global (EPG) is an online, corporate training provider company for IT related courses. The company is setting up their new campus in Mumbai. You as a network expert have to study the physical locations of various buildings and the number of computers to be installed. In the planning phase, provide the best possible answer for the

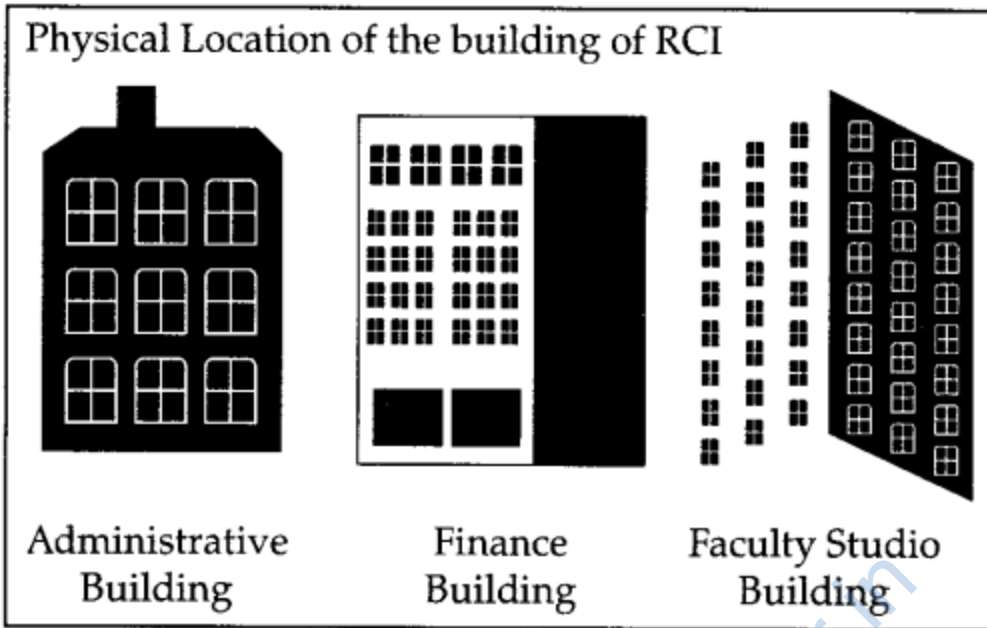

Building to Building distances (in Mtrs.)

From	To	Distance
Administrative Building	Finance Building	60
Administrative Building	Faculty Studio Building	120
Finance Building	Faculty Studio Building	70

Buildings	Computers
Administrative Building	20
Finance Building	40
Faculty Studio Building	120

1. Suggest the most appropriate building, where EPG should plan to install the server.

2. Suggest the most appropriate building to building cable layout to connect all three buildings for efficient communication.
3. Which type of network out of the following is formed by connecting the computers of these three buildings?
  - LAN
  - MAN
  - WAN
4. Which wireless channel out of the following should be opted by EPG to connect to students of all over the world?
  - Infrared
  - Microwave
  - Satellite

**Answer:**

1. Domain Name is alphanumeric address of a resource over network IP address is a Numeric Address of a resource in a Network.  
**Example:**  
Domain Name 1  
www.Gabsclasses.com  
IP Address  
102.112.0.153
2. Optical fibre Advantages:
  - Faster Communication.
  - Free from electrical & Noise interference.
3. (a) Faculty Studio Building  
(b) Bus Topology  
(c) LAN  
(d) Satellite

**Question 11:**

To provide telemedicine faculty in a hilly state, a computer network is to be setup to connect hospitals in 6 small villages (V1, V2, ..., V6) to the base hospital (H) in the state capital. This is shown in the following diagram.

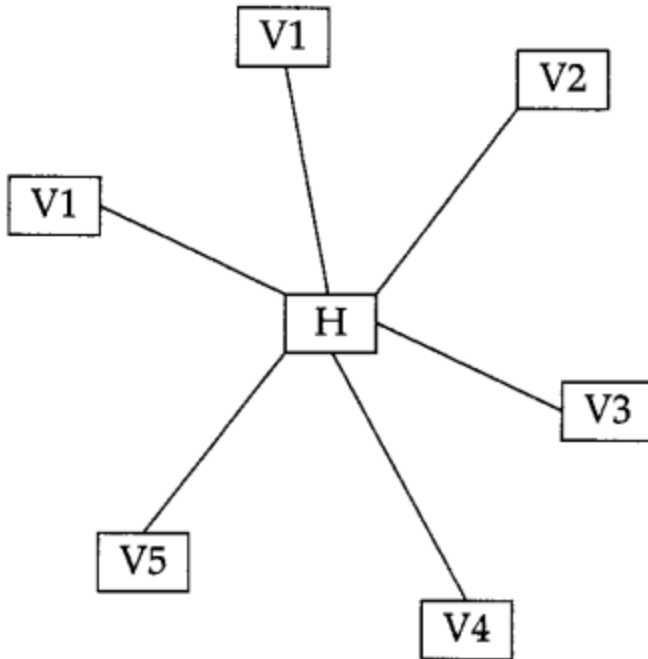

No village is more than 20 km away from the state capital.

Imagine yourself as a computer consultant for this project and answer the following questions with justification:

1. Out of the following what kind of link should be provided to setup this network: Microwave link, Radio Link, Wired Link ?
2. What kind of network will be formed; LAN, MAN, or WAN ?
3. Many times doctors at village hospital will have to consult senior doctors at the base hospital. For this purpose, how should they contact them: using email, sms, telephone, or video conference ?

(b) Out of SMTP and POP3 which protocol is used to receive emails ?

(c) What are cookies in the context of computer networks?

(d) Rajeshwari is trying for on-line subscription to a magazine. For this she has filled in a form on the magazine's web site. When she clicks submit button she gets a message that she has left e-mail field empty and she must fill it. For such checking which type of script is generally executed client side script or server-side script ?

(e) Mention any one difference between free-ware and free software.

**Answer:**

(a)

1. Radio Link
2. MAN

3. e-mail

(b) POP3

(c) Cookies are files that store user information that is used to identify the user when he logs into the system.

(d) Server-side script

(e) Freeware is a software that has the user to get unlimited usage for. Free software may be free for a certain period only.

**Question 12:**

Workalot Consultants are setting up a secured network for their office campus at Gurgaon for their day-to-day office and web-based activities. They are planning to have connectivity between three buildings and the head office situated in Mumbai. Answer the questions (i) to (iv) after going through the building positions in the campus and other details, which are given below :

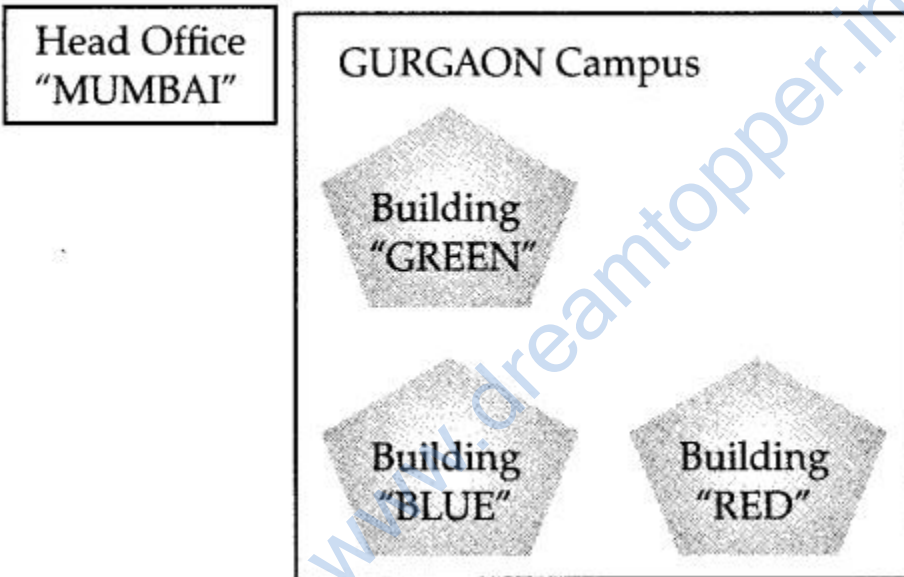

**Distances between various buildings:**

Building "GREEN" to Building "RED"	110 m
Building "GREEN" to Building "BLUE"	45 m
Building "BLUE" to Building "RED"	65 m
Gurgaon Campus to Head Office	1760 km

**Number of computers**

Building "GREEN"	32
Building "RED"	150
Building "BLUE"	45
Head Office	10

1. Suggest the most suitable place (i.e., building) to house the server of this organization. Also give a reason to justify your suggested location.
2. Suggest a cable layout of connections between the buildings inside the campus.
3. Suggest the placement of the following devices with justification:
  - Repeater.
  - Switch.
4. The organization is planning to provide a high speed link with its head office situated in Mumbai using a wired connection. Which of the following cables will be most suitable for this job ?
  - Optical Fiber
  - Co-axial Cable
  - Ethernet Cable

**Answer:**

1. The most suitable place to install server is building "RED" because this building have maximum computer which reduce communication delay.

(ii) Cable layout. (Bus topology).

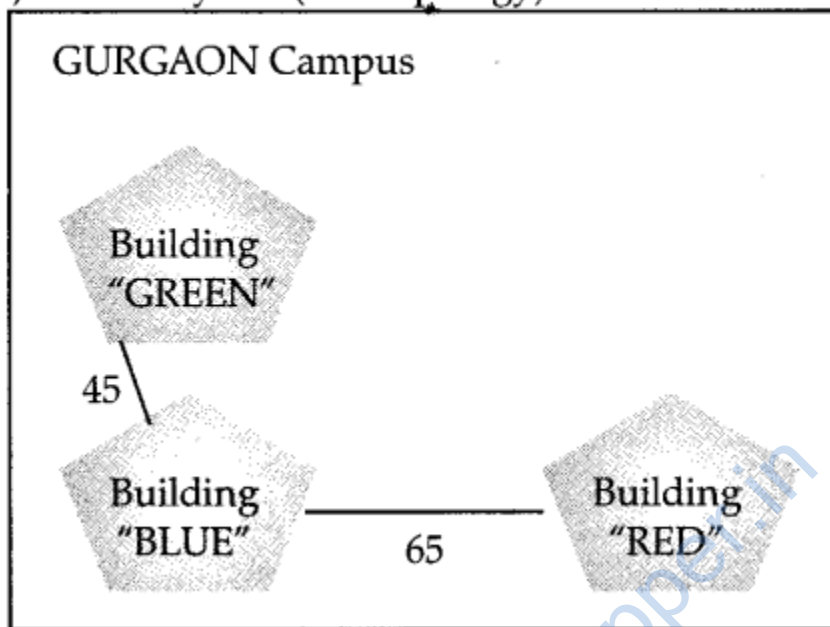

2. (a) Since the cabling distance between buildings GREEN, BLUE and RED are quite large, so a repeater each, would ideally be need along their path to avoid loss of signals during the course of data flow in there routes.

GURGAON Campus

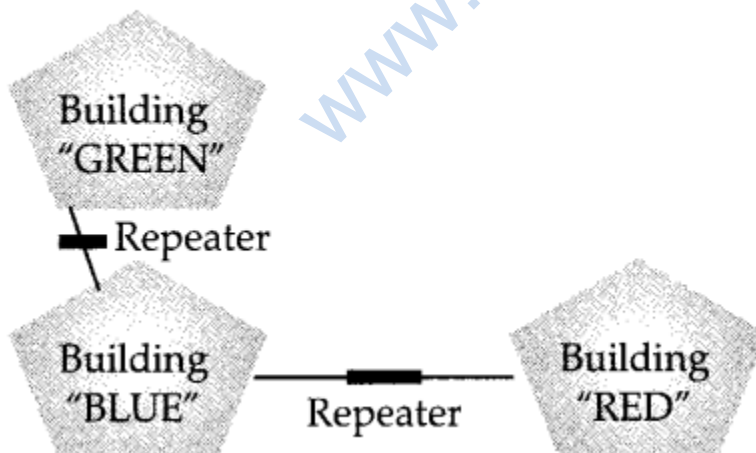

(b) In the layout a switch each, would be needed in all the buildings, to interconnect the group of cables from the different computers in each building.

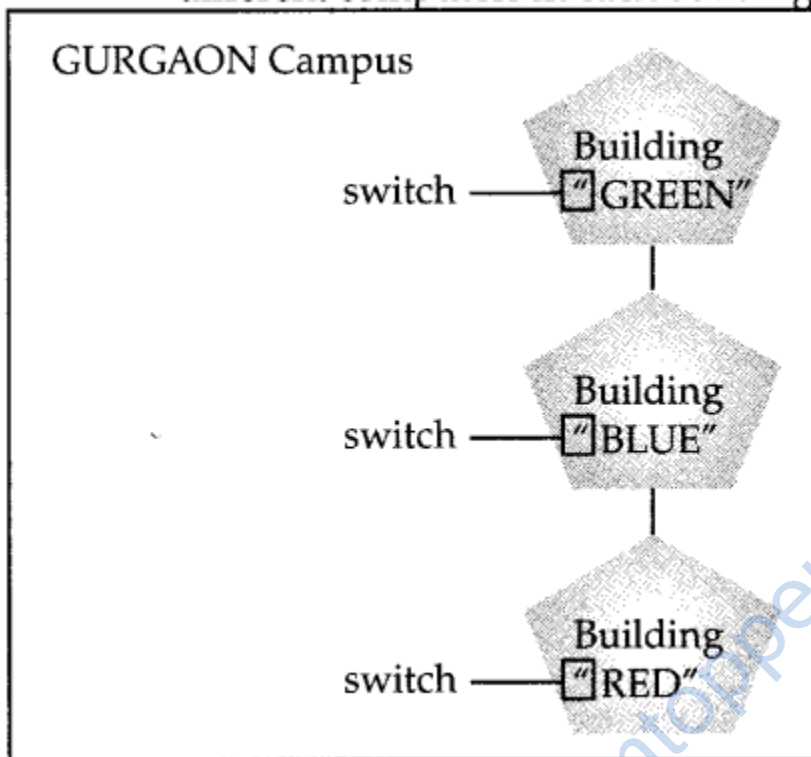

(iv) Optical fiber

**Question 13:**

Granuda Consultants are setting up a secured network for their office campus at Faridabad for their day to day office and web based activities. They are planning to have connectivity between 3 building and the head office situated in Kolkata. Answer the questions (i) to (iv) after going through the building positions in the campus and other details, which are given below:



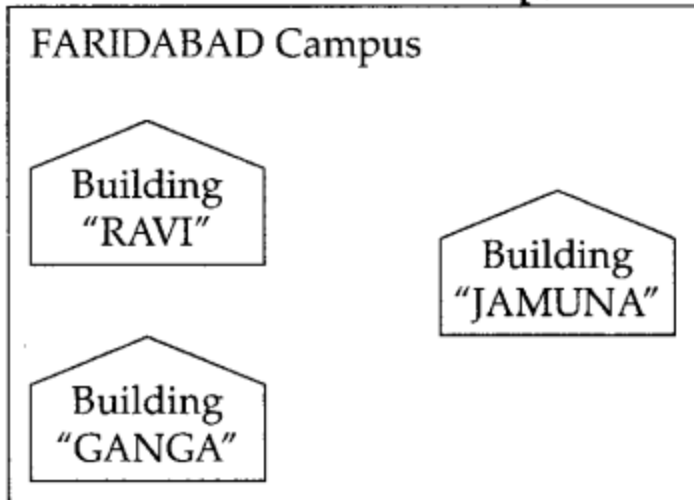

**Distances between various buildings:**

Building "RAVI" to Building "JAMUNA"	120 m
Building "RAVI" to Building "GANGA"	50 m
Building "GANGA" to Building "JAMUNA"	65 m
Faridabad Campus to Head Office	1460 km

**Number of Computers:**

Building "RAVI"	25
Building "JAMUNA"	150
Building "GANGA"	51
Head Office	10

1. Suggest the most suitable place (i.e., block) to house the server of this organization. Also give a reason to justify your suggested location.
2. Suggest a cable layout of connections between the buildings inside the campus.
3. Suggest the placement of the following devices with justification:
  - Repeater
  - Switch
4. The organization is planning to provide a high speed link with its head office situated in the KOLKATA using a wired connection. Which of the following cable will be most suitable for this job?

- Optical Fibre
- Co-axial Cable
- Ethernet Cable

**Answer:**

1. The most suitable place to install server is building "JAMUNA" because this building has maximum computers which reduce the communication delay.
2. Cable layout. (Bus topology).

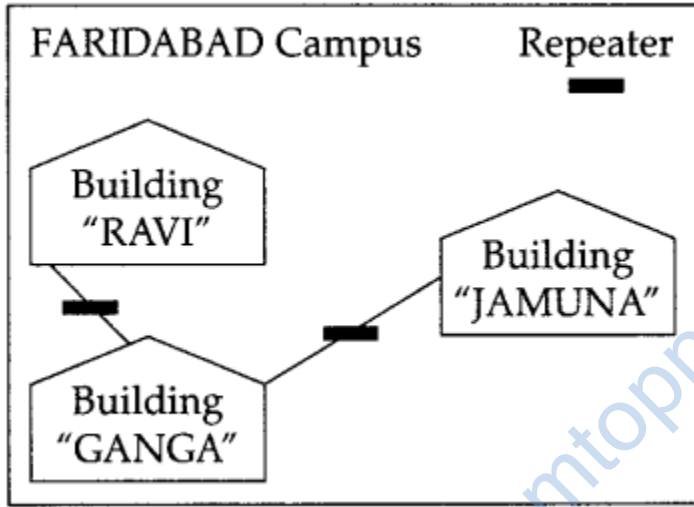

3. (a) Since the cabling distance between buildings GANGA and JAMUNA are quite large, so a repeater each, would ideally be needed along their path to avoid loss of signals during the course of data flow in these routes.

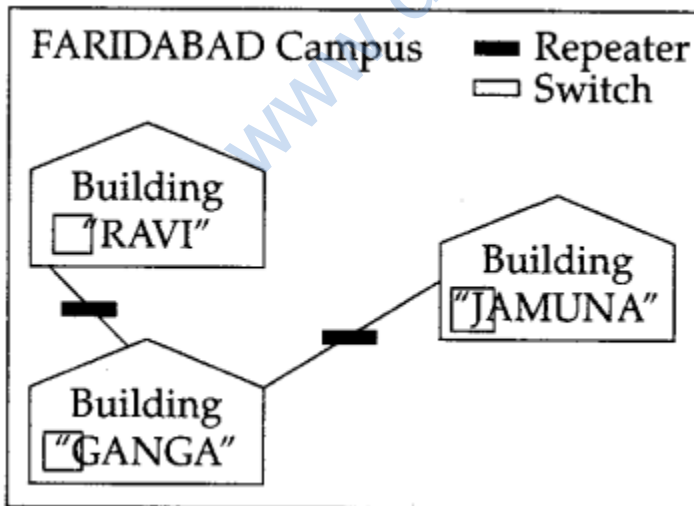

- (b) In the layout a switch each would be needed in all the building, to

interconnect the group of cables from the different computers in each building.

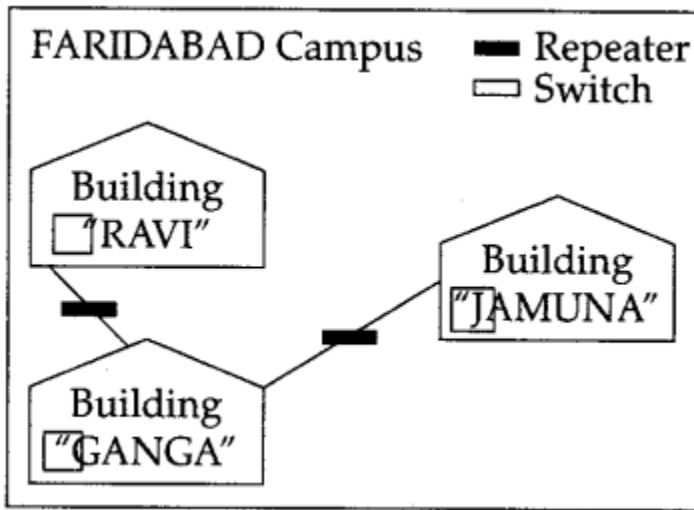

4. Optical fiber

**Question 14:**

India Skills Hub is a skill development community which has an aim to promote the standard of skills in the society. It is planning to set up its training centres in multiple towns and villages Pan India with its head offices in the nearest cities. They have created a model of their network with a city ABC Nagar, a town (UVW town) and 3 villages.

As a network consultant, you have to suggest the best network related solutions for their issues/ problems raised in (i) to (iv), keeping in mind the distances between various locations and other given parameters.

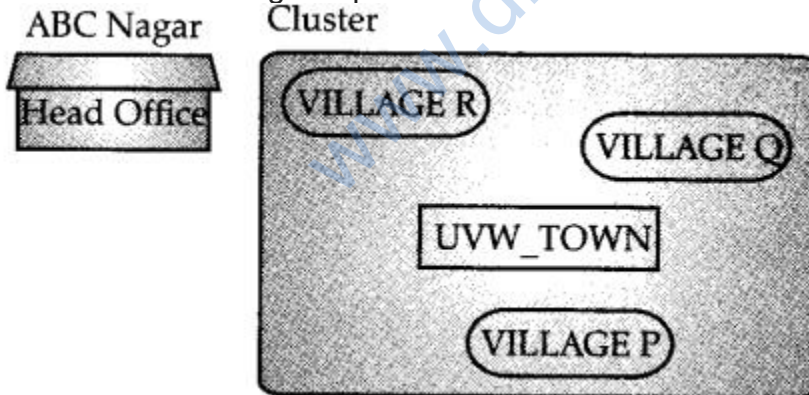

Shortest distances between various locations :

VILLAGE P TO UVW_TOWN	1.5 KM
VILLAGE Q TO UVW_TOWN	2.0 KM
VILLAGE R TO UVW_TOWN	1.0 KM
VILLAGE P TO VILLAGE Q	2.5 KM
VILLAGE P TO VILLAGE R	4.0 KM
VILLAGE Q TO VILLAGE R	2.3 KM
ABC Nagar Head Office to Cluster	28 KM

Number of computers installed at various locations are as follow :

UVW_TOWN	150
VILLAGE P	10
VILLAGE Q	15
VILLAGE R	20
ABC Nagar Head Office	5

**Note:**

- In Villagers, there are community centers, in which one room has been given as training entrer to this organization to install computers.
- The organization has got financial support from the government and top Multinational Organizations.

1. Suggest the most appropriate location of the SERVER in the Cluster (out of the 4 locations), to get the best and effective connectivity. Justify your answer.
2. Suggest the best wired medium and draw the cable layout (location to location) to efficiently connect various locations within the Cluster.
3. Which hardware device will you suggest to connect all the computers within each location of
4. Which service/protocol will be most helpful to conduct live interactions of Expersts from Head Office and peole at all locations of Cluster?

**Answer:**

1. Best location for the server is UVW-TOWN, because it is approximately equidistant from the village P, Q and R.
2. For connectivity between UVW-TOWN to head office is optic Fiber and to connect the villages, P, Q and R with server at UVW- TOWN is co-axial cable.
3. The villages R Q and R can be connected with server at UVW-TOWN by a Hub and the head office is connected by a Bus topology.
4. Between head office and UVWTOWN we recommend for Bus topology, so HTTP protocol and other terminal can be connected by UDP or FTP protocols.

**Question 15:**

Mudra publishing is a group of companies engaged in publishing IT related books located in the hilly area of Shimla. The companies are located in four different, blocks whose layout is shown in the following figure. Answer the questions (i) to (iv) with the relevant justifi-cations.

**Mudra publishing**

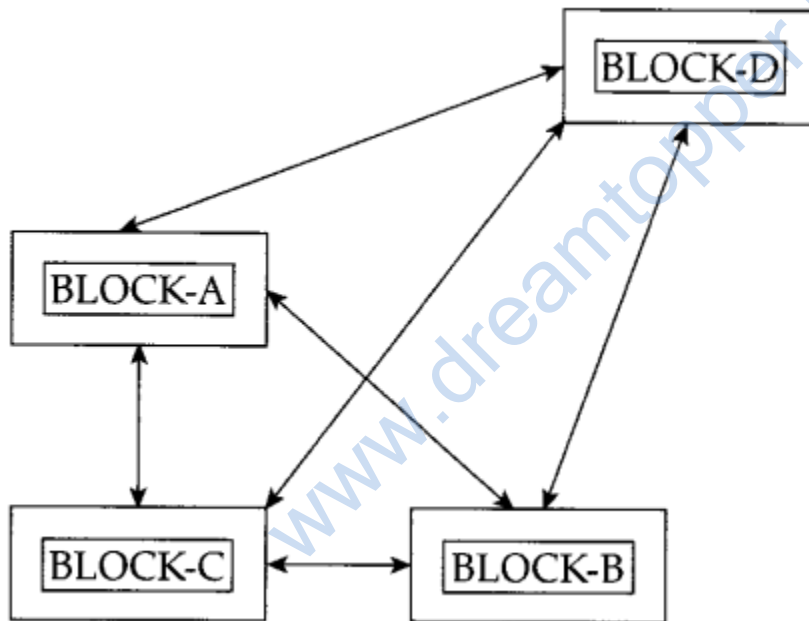

**Distance between various Blocks :**

1. Block A to Block C is 50 m
  2. Block A to Block D is 100 m
  3. Block B to Block C is 40 m
  4. Block B to Block D is 70 m
  5. Block C to Block D is 125 m
- Number of Computers
6. Block A is 25
  7. Block B is 50
  8. Block C is 20

9. Block D is 120

1. Suggest a suitable network topology between the blocks.
2. Which is the most suitable block to house the server of this organization?
3. Suggest the placement of the following devices with justification
  - Repeater
  - Switch
4. The organization is planning to link the whole blocks to its marketing Office in Delhi. Since cable connection is not possible from Shimla, suggest a way to connect it with high speed.

**Answer:**

1. Suitable topology is bus topology.
2. The most suitable block for hosting server is BLOCK-D because this block has maximum number of computers.

**Mudra Publishing**

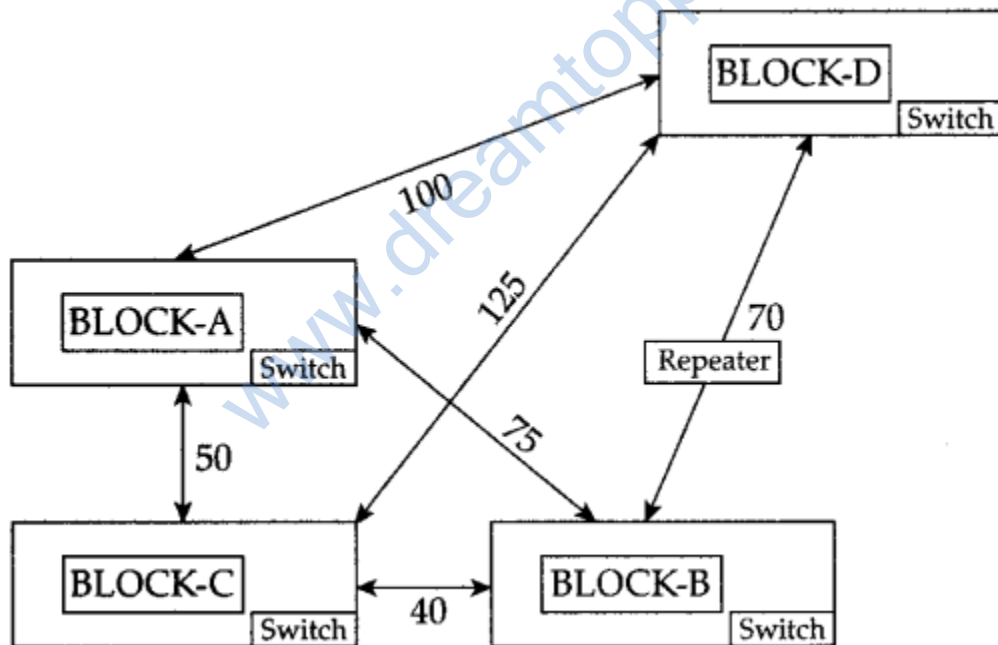

3. Switch is a device used to segment network into different sub-networks so switch will exist in all the blocks. Since distance between BLOCK-D and BLOCK-C is large so repeater will be install between BLOCK-D and BLOCK-C.
4. The most economic way to connect it with a reasonable high speed would be the use radiowave transmission, as they are easy to install, can travel long distance and penetrate buildings easily, so they are used for communication, both indoors and outdoors. Radiowaves also have the advantage of being omni-directional. They can travel in all the directions from the source, so that the transmitter and receiver do not have to be carefully aligned physically.

**TOPIC-2**  
**Network Security and Web Service**  
**Very Short Answer Type Questions(1 Mark each)**

**Question 1:**

Define firewall.

**Answer:**

A system designed to prevent unauthorized access to or from a private network is called firewall, it can be implemented in both hardware and software or combination of both.

**Question 2:**

Write any two examples of Server side Scripts.

**Answer:**

1. ASP
2. PHP

**Question 3:**

What is the difference between E-mail & chat?

**Answer:**

1. Chat occurs in near real time, while E-mail doesn't.
2. Chat is a 2-way communication which require the permission of both parties, while E-mail is a 1-way communication.

**Question 4:**

Write names of any two popular open source software, which are used as operating systems.

**Answer:**

1. Kernels
2. Unix
3. Linux

**Question 5:**

What is the difference between video conferencing and chat.

**Answer:**

In conference, we can include more than one person and it allows text video and audio while chat is one-to-one communication.

**Question 6:**

Expand the following abbreviations :

1. HTTP
2. VOIP

**Answer:**

1. HTTP-Hyper Text Transfer Protocol.
2. VOIP-Voice Over Internet Protocol.

**Question 7:**

What is the difference between HTTP and FTP?

**Answer:**

Hyper Text Transfer Protocol deals with Transfer of Text and Multimedia content over internet while FTP (File Transfer Protocol) deals with transfer of files over the internet.

**Question 8:**

What out of the following, will you use to have an audio-visual chat with an expert sitting in a far-away place to fix-up a technical issue ?

1. VoIP
2. email
3. FTP

**Answer:**

(i) VoIP 1

**Question 9:**

Name one server side scripting language and one client side scripting language.

**Answer:**

Client Side:

1. JAVASCRIPT
  2. VBSCRIPT
  3. ASP
  4. JSP
- Server Side



**Question 10:**

Which out of the following comes under cyber crime ?

1. Operating someone's internet banking account, without his knowledge.
2. Stealing a keyboard from someone's computer.
3. Working on someone's Computer with his/ her permission.

**Answer:**

(i) Operating someone's internet banking account, without his knowledge.

**Question 11:**

Name two proprietary software along with their application.

**Answer:**

1. MS-Office – All office applications MS-Word, MS-Excel, MS-PowerPoint.
2. Visual Studio – Visual Basic, Visual C++ software for application development.

**Question 12:**

Out of the following, identify client side script (s) and server side script (s).

1. ASP
2. Javascript
3. VBScript
4. JSP

**Answer:**

Server side scripting

1. ASP
  2. JSP
- Client side scripting
3. Javascript
  4. VBScript Vi

**Question 13:**

Compare open source software and proprietary software.

**Answer:**

One need an authorized license paid in order to use this proprietary software while open source software can be used by anybody and are usually free. One can use this software for

their personal use. After giving any notation or code in this type one cannot change the code or modify it.

**Question 14:**

Differentiate between XML and HTML.

**Answer:**

HTML		XML	
(i)	HTML Hyper Text Markup Language.	(i)	Extensible Markup Language.
(ii)	It has redefined tags and is designed to display data.	(ii)	It has user-defined tags and is designed to describe data.

**Question 15:**

What is WEB 2.0 ?

**Answer:**

Web2.0 refers to the new generation of web based services and communities characterised by participation, collaboration and sharing of information among users online.

**Question 16:**

Which of the following is/are not a client side script:

1. VB Script
2. Java Script
3. ASP
4. PHP ?

**Answer:**

(iii) ASP and  
(iv) PHP are not client side scripts.

**Question 17:**

If someone has hacked your website, to whom you lodge the complaint ?

**Answer:**

The complaint has to be lodged with the police under IT Act.

**Question 18:**

What do you mean by IP address? How is it useful in computer security ?

**Answer:**

An Internet Protocol (IP) address is a numerical identification and logical address that is assigned to devices connected in a computer network.

An IP address is used to uniquely identify devices on the internet and so one can quickly know the location of the system in the network. 1

**Question 19:**

What do you mean by spam mails ? How can you protect your mailbox from spams ?

**Answer:**

Spam mails, also known as junk e-mail, is a subset of spam that involves nearly identical messages sent to numerous recipients by e-mail.

We can protect our mailbox from spams by creating appropriate filters.

**Question 20:**

When do you prefer XML over HTML and why ?

**Answer:**

The first benefit of XML is that because you are writing your own markup language, you are not restricted to a limited set of tags defined by proprietary vendors.

Rather than waiting for standards bodies to adopt tag set enhancements (a process which can take quite some time), or for browser companies to adopt each other's standards with XML, you can create your own set of tags at your own place.

**Question 21:**

How does firewall protect our network ?

**Answer:**

A firewall is a part of a computer system or network, that is designed to block unauthorized access while permitting authorized communications. It is a device or set of devices configured to permit, deny, encrypt, decrypt, or proxy all (in and out) computer traffic between different security domains based upon a set of rules and, other criteria. 1

**Question 22:**

Compare freeware and shareware.

**Answer:**

**Freeware**, the name derived from the words “free” and “software”. It is a computer software that is available for use at no cost or for an optional fee. Freeware is generally proprietary software available at zero price, and is not free software. The author usually restricts one or more rights to copy, distribute, and make derivative works of the software.

Shareware is usually offered as a trial version with certain features only available after the license is purchased, or as a full version, but for a trial period. Once the trial period has passed, the program may stop running until a license is purchased. Shareware is often offered without support, updates, or help menus, which only become available with the purchase of a license. The words “free trial” or “trial version” are indicative of shareware.

**Question 23:**

How trojan horses are different from worms? Mention any one difference.

**Answer:**

A trojan horse is a term used to describe malware that appears to the user, to perform a desirable function but, in fact, facilitates unauthorized access, to the user’s computer system.

A computer worm is a self-replicating computer program. It uses a network to send copies of itself to the other nodes (computers on the network) and it may do so without any user intervention.

**Question 24:**

Give the full form of :

1. FOSS
2. HTTP

**Answer:**

1. **FOSS** : Free Open Source Software.
2. **HTTP** : Hyper Text Transfer Protocol.

**Question 25:**

What is the difference between trojan horse and virus in terms of computers ?

**Answer:**

A trojan, sometimes referred to as a trojan horse, is non-self-replicating malware that appears to perform a desirable function for the user but instead facilitates unauthorized access to the user’s computer system. The term is derived from the trojan horse story in greek mythology.

A computer virus is a computer program that can copy itself and infect a computer. A true virus can only spread from one computer to another.

The chief difference between a trojan horse and a virus is that a trojan horse does not replicate itself. A virus does. 1

**Question 26:**

Which term we use for a software/hardware device, which is used to block, unauthorized access while permitting authorized communications. This term is also used for a device or set of devices configured to permit, deny, encrypt, decrypt, or proxy all (in and out) computer traffic between different security domains based upon a set of rules and other criteria.

**Answer:**

Firewall.

**Question 27:**

Write the full forms of the following:

1. GNU
2. XML

**Answer:**

1. GNU stands for "GNU's Not Unix"
2. XML stands for "Extensible Markup Language".

**Question 28:**

Expand the following terminologies:

1. GSM
2. WLL (IMP)

**Answer:**

1. GSM: Global System for Mobile Communication
2. WLL: Wireless Local Loop.

**Question 29:**

Name some cyber offences under the IT Act.

**Answer:**

1. Tampering with computer source documents
2. Hacking.
3. Publishing of information which is obscene in electronic form.

**Question 30:**

What are the three ways of protecting intellectual property ?

**Answer:**

1. Patents
2. Copyrights
3. Trademark

**Question 31:**

When a user browses a website, the web server sends a text file to the web browser. What is the name of this?

**Answer:**

Cookies.

**Short Answer Type Questions**

**Question 1:**

Define the following:

1. Firewall
2. VoIE

**Answer:**

1. **Firewall:** A system designed to prevent unauthorized access to or from a private network is called firewall, it can be implemented in both hardware and software or combination of both.
2. **VoIP:** Voice-over-Internet Protocol(VoIP) is a methodology and group of technologies for the delivery of voice communications and multimedia sessions over Internet Protocol (IP) networks, such as the Internet.

**Question 2:**

Give the full form of the following terms.

1. XML
2. FLOSS
3. HTTP
4. FTP

**Answer:**

1. **XML:** Extensible Markup Language.

2. **FLOSS:** Free-Libre Open Source Software.
3. **HTTP:** Hyper Text Transfer Protocol.
4. **FTP:** File Transfer Protocol.

**Question 3:**

Differentiate between WORM and VIRUS in Computer terminology.

**Answer:**

VIRUS directly effects the system by corrupting the useful data. A computer virus attaches itself to a program or file enabling it to spread from one computer to another. A WORM is similar to a virus by design is considered to be subclass of a virus. Worm spread from computer to computer, but unlike a virus, it has the capability to travel without any human action. 2

**Question 4:**

Expand the following

1. GSM
2. GPRS.

**Answer:**

1. **GSM:** Global System for Mobile Communi-cation.
2. **GPRS:** General Packet Radio Service.

**Question 5:**

Expand the following abbreviations :

1. HTTP
2. VOIP

**Answer:**

1. **HTTP:** Hyper Text Transfer Protocol.
2. **VOIP:** Voice Over Internet Protocol.

**Question 6:**

Give the full form of :

1. FOSS
2. HTTP

**Answer:**

1. **FOSS:** Free Open Source Software.
2. **HTTP:** Hyper Text Transfer Protocol.

**Question 7:**

Write the full forms of the following :

1. GNU
2. XML

**Answer:**

1. **GNU:** GNU's Not Unix
2. **XML:** Xtensible Markup Language.

**Question 8:**

Expand the following terminologies :

1. GSM
2. WLL

**Answer:**

1. **GSM:** Global System for Mobile Communi-cation
2. **WLL:** Wireless Local Loop.

**Question 9:**

Give the full forms of the following terms :

1. CDMA
2. TDMA
3. FDMA

**Answer:**

1. **CDMA:** Code Division Multiple Access
2. **TDMA:** Time Division Multiple Access
3. **FDMA:** Frequency Division Multiple Access



**Question 10:**

Expand the following abbreviations :

1. FTP
2. TCP
3. SMTP
4. VOIP

**Answer:**

1. **FTP:** File Transfer Protocol
2. **TCP:** Transmission Control Protocol.
3. **SMTP:** Simple Mail Transfer Protocol.
4. **VOIP:** Voice Over Internet Protocol

[www.dreamtopper.in](http://www.dreamtopper.in)