

2

Motion in a Straight Line

Multiple Choice Questions (MCQs)

Q. 1 Among the four graphs shown in the figure there is only one graph for which average velocity over the time interval $(0, T)$ can vanish for a suitably chosen T . Which one is it?

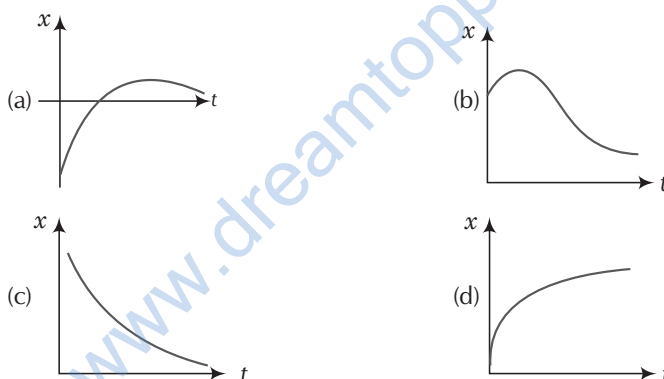

💡 Thinking Process

In this problem, we have to locate the graph which is having same displacement for two timings. When there are two timings for same displacement the corresponding velocities will be in opposite directions.

Ans. (b) In graph (b) for one value of displacement there are two different points of time. Hence, for one time, the average velocity is positive and for other time is equivalent negative.

As there are opposite velocities in the interval 0 to T hence average velocity can vanish in (b). *This can be seen in the figure given below*

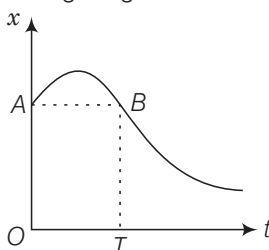

Here, $OA = BT$ (same displacement) for two different points of time.

Q. 2 A lift is coming from 8th floor and is just about to reach 4th floor. Taking ground floor as origin and positive direction upwards for all quantities, which one of the following is correct?

- (a) $x < 0, v < 0, a > 0$ (b) $x > 0, v < 0, a < 0$
 (c) $x > 0, v < 0, a > 0$ (d) $x > 0, v > 0, a < 0$

Ans. (a) As the lift is coming in downward directions displacement will be negative. We have to see whether the motion is accelerating or retarding.

We know that due to downward motion displacement will be negative. When the lift reaches 4th floor is about to stop hence, motion is retarding in nature hence, $x < 0; a > 0$.

As displacement is in negative direction, velocity will also be negative i.e., $v < 0$.

This can be shown on the adjacent graph.

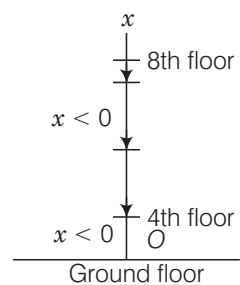

Q. 3 In one dimensional motion, instantaneous speed v satisfies $0 \leq v < v_0$.

- (a) The displacement in time T must always take non-negative values
 (b) The displacement x in time T satisfies $-v_0 T < x < v_0 T$
 (c) The acceleration is always a non-negative number
 (d) The motion has no turning points

Ans. (b) For maximum and minimum displacement we have to keep in mind the magnitude and direction of maximum velocity.

As maximum velocity in positive direction is v_0 maximum velocity in opposite direction is also v_0 .

Maximum displacement in one direction = $v_0 T$

Maximum displacement in opposite directions = $-v_0 T$

Hence, $-v_0 T < x < v_0 T$

Note We should not confuse with direction of velocities i.e., in one direction it is taken as positive and in another direction is taken as negative.

Q. 4 A vehicle travels half the distance l with speed v_1 and the other half with speed v_2 , then its average speed is

- (a) $\frac{v_1 + v_2}{2}$ (b) $\frac{2v_1 + v_2}{v_1 + v_2}$ (c) $\frac{2v_1 v_2}{v_1 + v_2}$ (d) $\frac{l(v_1 + v_2)}{v_1 v_2}$

Thinking Process

To calculate average speed we will calculate total distance covered and will divide by total time taken.

Ans. (c) Time taken to travel first half distance $t_1 = \frac{l/2}{v_1} = \frac{l}{2v_1}$

Time taken to travel second half distance $t_2 = \frac{l}{2v_2}$

$$\begin{aligned} \text{Total time} &= t_1 + t_2 \\ &= \frac{l}{2v_1} + \frac{l}{2v_2} = \frac{l}{2} \left[\frac{1}{v_1} + \frac{1}{v_2} \right] \end{aligned}$$

We know that,

$$V_{av} = \text{Average speed} = \frac{\text{total distance}}{\text{total time}}$$

$$= \frac{l}{\frac{l}{2} \left[\frac{1}{v_1} + \frac{1}{v_2} \right]} = \frac{2v_1v_2}{v_1 + v_2}$$

Note We should not confuse with distance and displacement. Distance \geq displacement.

- Q. 5** The displacement of a particle is given by $x = (t - 2)^2$ where x is in metre and t in second. The distance covered by the particle in first 4 seconds is
- (a) 4 m (b) 8 m (c) 12 m (d) 16 m

Thinking Process

In such type of problems we have to see whether the motion is accelerating or retarding. During retarding journey particle will stop in between.

Ans. (b) Given, $x = (t - 2)^2$

Velocity, $v = \frac{dx}{dt} = \frac{d}{dt}(t - 2)^2 = 2(t - 2) \text{ m/s}$

Acceleration, $a = \frac{dv}{dt} = \frac{d}{dt}[2(t - 2)]$
 $= 2[1 - 0] = 2 \text{ m/s}^2$

When, $t = 0; v = -4 \text{ m/s}$
 $t = 2\text{s}; v = 0 \text{ m/s}$
 $t = 4\text{s}; v = 4 \text{ m/s}$

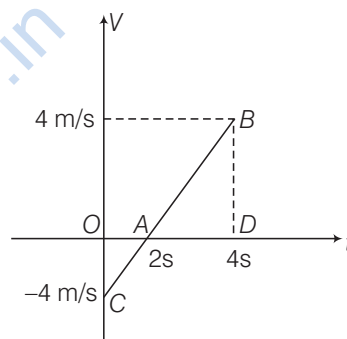

$v-t$ graph is shown in adjacent diagram.

Distance travelled = area of the graph
 $= \text{area OAC} + \text{area ABD}$
 $= \frac{4 \times 2}{2} + \frac{1}{2} \times 2 \times 4 = 8 \text{ m}$

- Q. 6** At a metro station, a girl walks up a stationary escalator in time t_1 . If she remains stationary on the escalator, then the escalator take her up in time t_2 . The time taken by her to walk up on the moving escalator will be
- (a) $(t_1 + t_2) / 2$ (b) $t_1 t_2 / (t_2 - t_1)$ (c) $t_1 t_2 / (t_2 + t_1)$ (d) $t_1 - t_2$

Ans. (c) In this question, we have to find net velocity with respect to the Earth that will be equal to velocity of the girl plus velocity of escalator.

Let displacement is L , then

$$\text{velocity of girl } v_g = \frac{L}{t_1}$$

$$\text{velocity of escalator } v_e = \frac{L}{t_2}$$

$$\text{Net velocity of the girl} = v_g + v_e = \frac{L}{t_1} + \frac{L}{t_2}$$

If t is total time taken in covering distance L , then

$$\frac{L}{t} = \frac{L}{t_1} + \frac{L}{t_2} \Rightarrow t = \frac{t_1 t_2}{t_1 + t_2}$$

Multiple Choice Questions (More Than One Options)

Q. 7 The variation of quantity A with quantity B , plotted in figure. Describes the motion of a particle in a straight line.

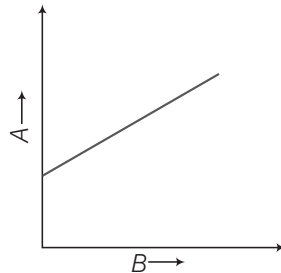

- (a) Quantity B may represent time
- (b) Quantity A is velocity if motion is uniform
- (c) Quantity A is displacement if motion is uniform
- (d) Quantity A is velocity if motion is uniformly accelerated

Ans. (a, c, d)

When we are calculating velocity of a displacement-time graph we have to take slope similarly we have to take slope of velocity-time graph to calculate acceleration. When slope is constant motion will be uniform.

When we are representing motion by a graph it may be displacement-time, velocity-time or acceleration-time hence, B may represent time. For uniform motion velocity-time graph should be a straight line parallel to time axis. For uniform motion velocity is constant hence, slope will be positive. Hence quantity A is displacement.

For uniformly accelerated motion slope will be positive and A will represent velocity.

Q. 8 A graph of x versus t is shown in figure. Choose correct alternatives given below

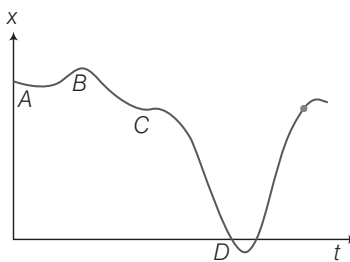

- (a) The particle was released from rest at $t = 0$
- (b) At B , the acceleration $a > 0$
- (c) Average velocity for the motion between A and D is positive
- (d) The speed at D exceeds that at E

Thinking Process

In this problem, we have to apply formula for slope = $\frac{dx}{dt}$ for the graph and velocity

$$v = \frac{dx}{dt}$$

Ans. (a, c, d)

As per the diagram, at point A the graph is parallel to time axis hence, $v = \frac{dx}{dt} = 0$. As the

starting point is A hence, we can say that the particle is starting from rest.

At C, the graph changes slope, hence, velocity also changes. As graph at C is almost parallel to time axis hence, we can say that velocity vanishes.

As direction of acceleration changes hence, we can say that it may be zero in between.

From the graph it is clear that

$$|\text{slope at } D| > |\text{slope at } E|$$

Hence, speed at D will be more than at E.

Note We should be very clear about magnitude of slope. Negative slope does not mean less value. It represents change in direction of velocity.

Q. 9 For the one-dimensional motion, described by $x = t - \sin t$

(a) $x(t) > 0$ for all $t > 0$

(b) $v(t) > 0$ for all $t > 0$

(c) $a(t) > 0$ for all $t > 0$

(d) $v(t)$ lies between 0 and 2

Ans. (a, d)

Given,

$$\begin{aligned} x &= t - \sin t \\ \text{velocity } v &= \frac{dx}{dt} = \frac{d}{dt}[t - \sin t] \\ &= 1 - \cos t \\ \text{Acceleration } a &= \frac{dv}{dt} = \frac{d}{dt}[1 - \cos t] = \sin t \end{aligned}$$

As acceleration

$$a > 0 \text{ for all } t > 0$$

Hence,

$$x(t) > 0 \text{ for all } t > 0$$

$$\text{Velocity } v = 1 - \cos t$$

When,

$$\cos t = 1, \text{ velocity } v = 0$$

$$v_{\max} = 1 - (\cos t)_{\min} = 1 - (-1) = 2$$

$$v_{\min} = 1 - (\cos t)_{\max} = 1 - 1 = 0$$

Hence, v lies between 0 and 2.

$$\text{Acceleration } a = \frac{dv}{dt} = -\sin t$$

When $t = 0$; $x = 0$, $x = +1$, $a = 0$

When $t = \frac{\pi}{2}$; $x = 1$, $v = 0$, $a = -1$

When $t = \pi$; $x = 0$, $x = -1$, $a = 1$

When $t = 2\pi$; $x = 0$, $x = 0$, $a = 0$

Note (i) When sinusoidal function is involved in an expression we should be careful about sine and cosine functions.

(ii) We should be very careful when calculating maximum and minimum value of velocity because it involves inverse relation with $\cos t$ in the given expression.

Q. 10 A spring with one end attached to a mass and the other to a rigid support is stretched and released.

(a) Magnitude of acceleration, when just released is maximum

(b) Magnitude of acceleration, when at equilibrium position, is maximum

(c) Speed is maximum when mass is at equilibrium position

(d) Magnitude of displacement is always maximum whenever speed is minimum

Ans. (a, c)

When spring is stretched by x , restoring force will be $F = -kx$

Potential energy of the stretched spring = PE = $\frac{1}{2}kx^2$

The restoring force is central hence, when particle released it will execute SHM about equilibrium position.

Acceleration will be $a = \frac{F}{m} = \frac{-kx}{m}$

At equilibrium position, $x = 0 \Rightarrow a = 0$

Hence, when just released $x = x_{\max}$

Hence, acceleration is maximum. Thus option (a) is correct.

At equilibrium whole PE will be converted to KE hence, KE will be maximum and hence, speed will be maximum.

Q. 11 A ball is bouncing elastically with a speed 1 m/s between walls of a railway compartment of size 10 m in a direction perpendicular to walls. The train is moving at a constant velocity of 10 m/s parallel to the direction of motion of the ball. As seen from the ground.

- (a) The direction of motion of the ball changes every 10 .
- (b) Speed of ball changes every 10
- (c) Average speed of ball over any 20 interval is fixed.
- (d) The acceleration of ball is the same as from the train

Ans. (b, c, d)

In this problem, we have to keep in mind the frame of the observer. Here we must be clear that we are considering the motion from the ground. Compare to velocity of trains (10 m/s) speed of ball is less (1 m/s).

The speed of the ball before collision with side of train is $10 + 1 = 11$ m/s.

Speed after collision with side of train = $10 - 1 = 9$ m/s.

As speed is changing after travelling 10 m and speed is 1 m/s hence, time duration of the changing speed is 10.

Since, the collision of the ball is perfectly elastic there is no dissipation of energy hence, total momentum and kinetic energy are conserved.

Since, the train is moving with constant velocity hence, it will act as inertial frame of reference as that of Earth and acceleration will be same in both frames.

We should not confuse with non-inertial and inertial frame of reference. A frame of reference that is not accelerating will be inertial.

Very Short Answer Type Questions

Q. 12 Refer to the graph in figure. Match the following

Graph	Characteristics
(a)	(i) has $v > 0$ and $a < 0$ throughout
(b)	(ii) has $x > 0$ throughout and has a point with $v = 0$ and a point with $a = 0$
(c)	(iii) has a point with zero displacement for $t > 0$
(d)	(iv) has $v < 0$ and $a > 0$

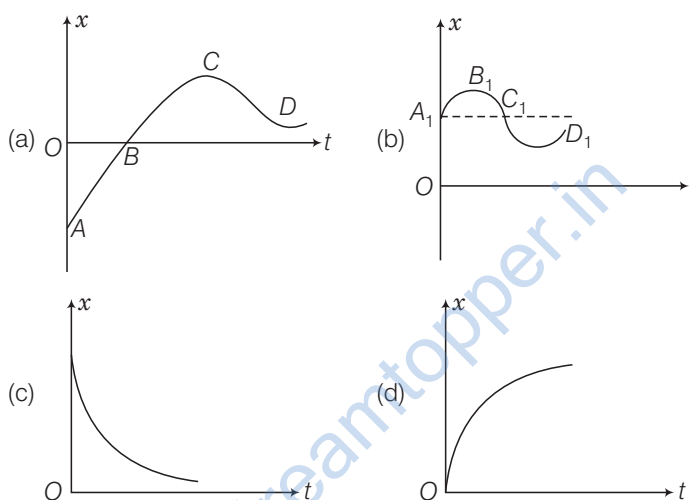

Ans. We have to analyse slope of each curve i.e., $\frac{dx}{dt}$. For peak points $\frac{dx}{dt}$ will be zero as x is maximum at peak points.
 For graph (a), there is a point (B) for which displacement is zero. So, a matches with (iii)
 In graph (b), x is positive (> 0) throughout and at point B_1 , $V = \frac{dx}{dt} = 0$.
 since, at point of curvature changes $a = 0$, So b matches with (ii)
 In graph (c), slope $V = \frac{dx}{dt}$ is negative hence, velocity will be negative.
 so matches with (iv)
 In graph (d), as slope $V = \frac{dx}{dt}$ is positive hence, $V > 0$
 Hence, d matches with (i)

Q. 13 A uniformly moving cricket ball is turned back by hitting it with a bat for a very short time interval. Show the variation of its acceleration with time (Take acceleration in the backward direction as positive).

Ans. If gravity effect is neglected then ball moving uniformly turned back with same speed when a bat hit it. Acceleration of the ball is zero just before it strikes the bat. When the ball strikes the bat, it gets accelerated due to the applied impulsive force by the bat.

The variation of acceleration with time is shown in graph

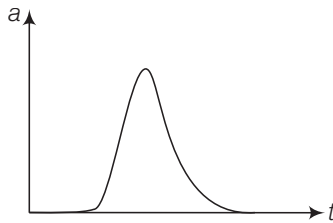

Q. 14 Give examples of a one-dimensional motion where

- (a) the particle moving along positive x -direction comes to rest periodically and moves forward.
- (b) the particle moving along positive x -direction comes to rest periodically and moves backward.

Ans. When we are writing an equation belonging to periodic nature it will involve sine or cosine function.

(a) The particle will be moving along positive x -direction only if $t > \sin t$

Hence,

$$x(t) = 1 - \sin t$$

$$\text{Velocity } v(t) = \frac{dx(t)}{dt} = 1 - \cos t$$

$$\text{Acceleration } a(t) = \frac{dv}{dt} = \sin t$$

When

$$t = 0; x(t) = 0$$

When

$$t = \pi; x(t) = \pi > 0$$

When

$$t = 2\pi; x(t) = 2\pi > 0$$

(b) Equation can be represented by

$$x(t) = \sin t$$

$$v = \frac{d}{dt} x(t) = \cos t$$

As displacement and velocity is involving $\sin t$ and $\cos t$ hence these equations represent periodic.

Q. 15 Give example of a motion where $x > 0, v < 0, a > 0$ at a particular instant.

Ans. Let the motion is represented by

$$x(t) = A + Be^{-\gamma t} \quad \dots(i)$$

Let

$$A > B \quad \text{and} \quad \gamma > 0$$

Now velocity

$$v(t) = \frac{dx}{dt} = -B\gamma e^{-\gamma t}$$

Acceleration

$$a(t) = \frac{dv}{dt} = B\gamma^2 e^{-\gamma t}$$

Suppose we are considering any instant t , then from Eq. (i), we can say that

$$x(t) > 0; v(t) < 0 \quad \text{and} \quad a > 0$$

Q. 16 An object falling through a fluid is observed to have acceleration given by $a = g - bv$ where g = gravitational acceleration and b is constant. After a long time of release, it is observed to fall with constant speed. What must be the value of constant speed?

Ans. When speed becomes constant acceleration $a = \frac{dv}{dt} = 0$

Given acceleration

$$a = g - bv$$

where, g = gravitational acceleration

Clearly, from above equation as speed increases acceleration will decrease. At a certain speed say v_0 , acceleration will be zero and speed will remain constant.

Hence,

$$a = g - bv_0 = 0$$

\Rightarrow

$$v_0 = g/b$$

Short Answer Type Questions

Q. 17 A ball is dropped and its displacement *versus* time graph is as shown (Displacement x from ground and all quantities are positive upwards).

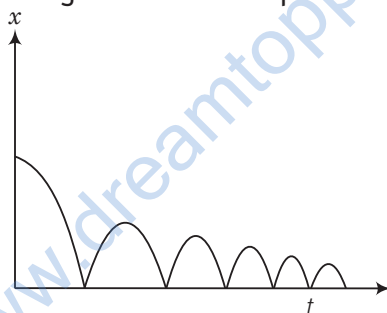

(a) Plot qualitatively velocity *versus* time graph

(b) Plot qualitatively acceleration *versus* time graph

💡 Thinking Process

To calculate velocity we will find slope $\frac{dx}{dt}$ for displacement-time curve and to find

acceleration we will find slope $\frac{dV}{dt}$ of velocity-time curve.

Ans. It is clear from the graph that displacement x is positive throughout. Ball is dropped from a height and its velocity increases in downward direction due to gravity pull. In this condition v is negative but acceleration of the ball is equal to acceleration due to gravity *i.e.*, $a = -g$. When ball rebounds in upward direction its velocity is positive but acceleration is $a = -g$.

(a) The velocity-time graph of the ball is shown in fig. (i).

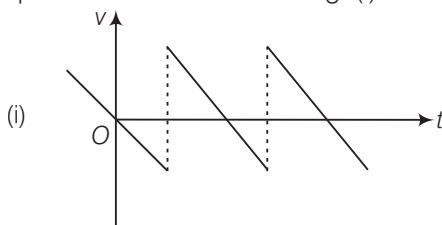

(b) The acceleration-time graph of the ball is shown in fig. (ii).

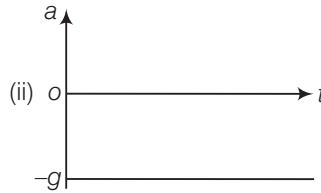

Q. 18 A particle executes the motion described by $x(t) = x_0(1 - e^{-\gamma t})$; $t \geq 0$, $x_0 > 0$.

- (a) Where does the particle start and with what velocity?
- (b) Find maximum and minimum values of $x(t)$, $v(t)$, $a(t)$. Show that $x(t)$ and $a(t)$ increase with time and $v(t)$ decreases with time.

Thinking Process

First we have to calculate velocity and acceleration and then we can determine the maximum or minimum value accordingly.

Ans. Given,

$$x(t) = x_0(1 - e^{-\gamma t})$$

$$v(t) = \frac{dx(t)}{dt} = x_0\gamma e^{-\gamma t}$$

$$a(t) = \frac{dv(t)}{dt} = -x_0\gamma^2 e^{-\gamma t}$$

- (a) When $t = 0$; $x(t) = x_0(1 - e^{-0}) = x_0(1 - 1) = 0$
 $x(t = 0) = x_0\gamma e^{-0} = x_0\gamma(1) = \gamma x_0$

- (b) $x(t)$ is maximum when $t = \infty$ $[x(t)]_{\max} = x_0$
 $x(t)$ is minimum when $t = 0$ $[x(t)]_{\min} = 0$
 $v(t)$ is maximum when $t = 0$; $v(0) = x_0\gamma$
 $v(t)$ is minimum when $t = \infty$; $v(\infty) = 0$
 $a(t)$ is maximum when $t = \infty$; $a(\infty) = 0$
 $a(t)$ is minimum when $t = 0$; $a(0) = -x_0\gamma^2$

Note We should be careful about nature of variation of the curve and maximum and minimum value will be decided accordingly.

Q. 19 A bird is tossing (flying to and fro) between two cars moving towards each other on a straight road. One car has a speed of 18 km/h while the other has the speed of 27 km/h. The bird starts moving from first car towards the other and is moving with the speed of 36 km/h and when the two cars were separated by 36 km. What is the total distance covered by the bird?

Thinking Process

In this problem we have to use the concept of relative velocity it will be subtracted for velocities in same direction and added for velocities in opposite directions.

Ans. Given, Speed of first car = 18 km/h
 Speed of second car = 27 km/h
 \therefore Relative speed of each car w.r.t. each other
 $= 18 + 27 = 45 \text{ km/h}$

Distance between the cars = 36 km

$$\therefore \text{Time of meeting the cars } (t) = \frac{\text{Distance between the cars}}{\text{Relative speed of cars}} = \frac{36}{45} = \frac{4}{5} \text{ h} = 0.8 \text{ h}$$

Speed of the bird (v_b) = 36 km/h

$$\therefore \text{Distance covered by the bird} = v_b \times t = 36 \times 0.8 = 28.8 \text{ km}$$

- Q. 20** A man runs across the roof, top of a tall building and jumps horizontally with the hope of landing on the roof of the next building which is at a lower height than the first. If his speed is 9 m/s, the (horizontal) distance between the two buildings is 10 m and the height difference is 9 m, will he be able to land on the next building? (Take $g = 10 \text{ m/s}^2$)

Thinking Process

When the man runs on the roof-top the velocity will be horizontal. Then, acceleration will be vertically down ward taken as g and then equations of kinematics will be applied.

Ans. Given, horizontal speed of the man (u_x) = 9 m/s

Horizontal distance between the two buildings = 10 m

Height difference between the two buildings = 9 m

and

$$g = 10 \text{ m/s}^2$$

Let the man jumps from point A and land on the roof of the next building at point B.

Taking motion in vertical direction,

$$y = ut + \frac{1}{2}at^2$$

$$9 = 0 \times t + \frac{1}{2} \times 10 \times t^2$$

$$9 = 5t^2$$

$$t = \sqrt{\frac{9}{5}} = \frac{3}{\sqrt{5}}$$

or

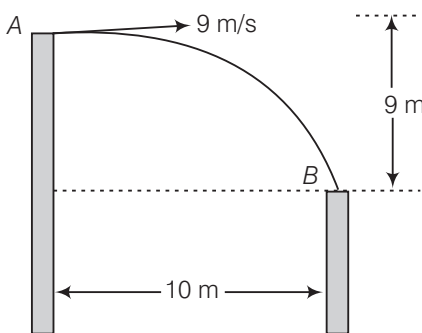

$$\therefore \text{Horizontal distance travelled} = u_x \times t = 9 \times \frac{3}{\sqrt{5}} = \frac{27}{\sqrt{5}} \text{ m}$$

$$\approx 12 \text{ m}$$

Horizontal distance travelled by the man is greater than 10 m, therefore, he will land on the next building.

Q. 21 A ball is dropped from a building of height 45 m. Simultaneously another ball is thrown up with a speed 40 m/s. Calculate the relative speed of the balls as a function of time.

Thinking Process

In this problem as ball is dropped, initial velocity will be taken as zero. We will apply equations involving one dimensional motion.

Ans. For the ball dropped from the building, $u_1 = 0, u_2 = 40\text{ m/s}$

Velocity of the dropped ball after time t ,

$$v_1 = u_1 + gt$$

$$v_1 = gt \quad \text{(downward)}$$

For the ball thrown up, $u_2 = 40\text{ m/s}$

Velocity of the ball after time t

$$v_2 = u_2 - gt \\ = (40 - gt)$$

(upward)

\therefore Relative velocity of one ball w.r.t. another ball

$$= v_1 - v_2 \\ = gt - [-(40 - gt)] = 40\text{ m/s}$$

Note When we are applying equations for rectilinear motion we should carefully put up the signs for the physical quantities.

Q. 22 The velocity- displacement graph of a particle is shown in figure.

- Write the relation between v and x .
- Obtain the relation between acceleration and displacement and plot it.

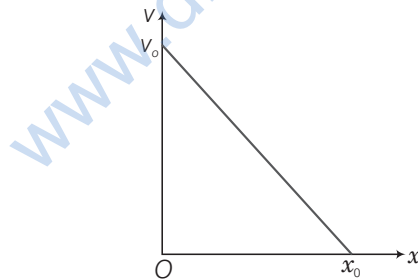

Thinking Process

In this problems we will use the concept of slope. Suppose the slope is m then equation will come out to be $y = mx + c$.

Ans. Given, initial velocity = v_0

Let the distance travelled in time $t = x_0$.

For the graph
$$\tan \theta = \frac{v_0}{x_0} = \frac{v_0 - v}{x} \quad \dots(i)$$

where, v is velocity and x is displacement at any instant of time t .

From Eq. (i)
$$v_0 - v = \frac{v_0}{x_0} x$$

\Rightarrow
$$v = \frac{-v_0}{x_0} x + v_0$$

We know that

$$\begin{aligned} \text{Acceleration } a &= \frac{dv}{dt} = \frac{-v_0}{x_0} \frac{dx}{dt} + 0 \\ \Rightarrow a &= \frac{-v_0}{x_0} (v) \\ &= \frac{-v_0}{x_0} \left(\frac{-v_0}{x_0} x + v_0 \right) \\ &= \frac{v_0^2}{x_0^2} x - \frac{v_0^2}{x_0} \end{aligned}$$

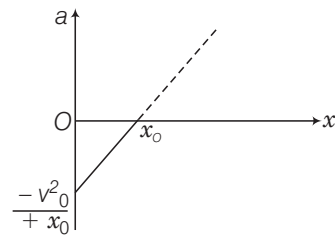

Graph of a versus x is given above.

Long Answer Type Questions

Q. 23 It is a common observation that rain clouds can be at about a kilometer altitude above the ground.

- If a rain drop falls from such a height freely under gravity, what will be its speed? Also calculate in km/h ($g = 10 \text{ m/s}^2$).
- A typical rain drop is about 4 mm diameter. Momentum is mass \times speed in magnitude. Estimate its momentum when it hits ground.
- Estimate the time required to flatten the drop.
- Rate of change of momentum is force. Estimate how much force such a drop would exert on you.
- Estimate the order of magnitude force on umbrella. Typical lateral separation between two rain drops is 5 cm.

(Assume that umbrella is circular and has a diameter of 1 m and cloth is not pierced through.)

Thinking Process

In this problem equation of motion and Newton's second law that is $F_{\text{ext}} = \frac{dp}{dt}$ will be used. where dp is change in momentum over time dt .

Ans. Given, height (h) = 1 km = 1000 m
 $g = 10 \text{ m/s}^2$

- (a) Velocity attained by the rain drop in freely falling through a height h .

$$\begin{aligned} v &= \sqrt{2gh} = \sqrt{2 \times 10 \times 1000} = 100\sqrt{2} \text{ m/s} \\ &= 100\sqrt{2} \times \frac{60 \times 60}{1000} \text{ km/h} \\ &= 360\sqrt{2} \text{ km/h} \approx 510 \text{ km/h} \end{aligned}$$

- (b) Diameter of the drop (d) = $2r = 4 \text{ mm}$
 \therefore Radius of the drop (r) = $2 \text{ mm} = 2 \times 10^{-3} \text{ m}$

Mass of a rain drop (m) = $V \times \rho$

$$\begin{aligned} &= \frac{4}{3} \pi r^3 \rho \\ &= \frac{4}{3} \times \frac{22}{7} \times (2 \times 10^{-3})^3 \times 10^3 \quad (\because \text{Density of water} = 10^3 \text{ kg/m}^3) \\ &\approx 3.4 \times 10^{-5} \text{ kg} \end{aligned}$$

Momentum of the rain drop (p) = mv

$$\begin{aligned} &= 3.4 \times 10^{-5} \times 100\sqrt{2} \\ &= 4.7 \times 10^{-3} \text{ kg-m/s} \\ &\approx 5 \times 10^{-3} \text{ kg-m/s} \end{aligned}$$

(c) Time required to flatten the drop = time taken by the drop to travel the distance equal to the diameter of the drop near the ground

$$\begin{aligned} t &= \frac{d}{v} = \frac{4 \times 10^{-3}}{100\sqrt{2}} = 0.028 \times 10^{-3} \text{ s} \\ &= 2.8 \times 10^{-5} \text{ s} \approx 30 \text{ ms} \end{aligned}$$

(d) Force exerted by a rain drop

$$\begin{aligned} F &= \frac{\text{Change in momentum}}{\text{Time}} = \frac{p - 0}{t} \\ &= \frac{4.7 \times 10^{-3}}{2.8 \times 10^{-5}} \approx 168 \text{ N} \end{aligned}$$

(e) Radius of the umbrella (R) = $\frac{1}{2}$ m

$$\therefore \text{Area of the umbrella (A)} = \pi R^2 = \frac{22}{7} \times \left(\frac{1}{2}\right)^2 = \frac{22}{28} = \frac{11}{14} \approx 0.8 \text{ m}^2$$

Number of drops striking the umbrella simultaneously with average separation of 5 cm = 5×10^{-2} m.

$$= \frac{0.8}{(5 \times 10^{-2})^2} = 320$$

\therefore Net force exerted on umbrella = $320 \times 168 = 53760 \text{ N} \approx 54000 \text{ N}$

Note In practice, the velocity of the drops decreases due to air friction.

Q. 24 A motor car moving at a speed of 72 km/h cannot come to a stop in less than 3.0 s while for a truck this time interval is 5.0 s. On a highway, the car is behind the truck both moving at 72 km/h. The truck gives a signal that it is going to stop at emergency. At what distance the car should be from the truck so that it does not bump onto (collide with) the truck. Human response time is 0.5 s.

Ans. In this problem equations related to one dimensional motion will be applied for acceleration positive sign will be used and for retardation negative sign will be used.

Given, speed of car as well as truck = 72 km/h

$$= 72 \times \frac{5}{18} \text{ m/s} = 20 \text{ m/s}$$

Retarded motion for truck

$$v = u + a_t t$$

$$0 = 20 + a_t \times 5$$

or

$$a_t = -4 \text{ m/s}^2$$

Retarded motion for the car

$$v = u + a_c t$$

$$0 = 20 + a_c \times 3$$

or

$$a_c = -\frac{20}{3} \text{ m/s}^2$$

Let car be at a distance x from truck, when truck gives the signal and t be the time taken to cover this distance.

As human response time is 0.5 s, therefore, time of retarded motion of car is $(t - 0.5)$ s.

Velocity of car after time t ,

$$v_c = u - at$$

$$= 20 - \left(\frac{20}{3}\right)(t - 0.5)$$

Velocity of truck after time t ,

$$v_t = 20 - 4t$$

To avoid the car bump onto the truck,

$$v_c = v_t$$

$$20 - \frac{20}{3}(t - 0.5) = 20 - 4t$$

$$4t = \frac{20}{3}(t - 0.5)$$

$$t = \frac{5}{3}(t - 0.5)$$

$$3t = 5t - 2.5$$

\Rightarrow

$$t = \frac{2.5}{2} = \frac{5}{4} \text{ s}$$

Distance travelled by the truck in time t ,

$$s_t = u_t t + \frac{1}{2} a_t t^2$$

$$= 20 \times \frac{5}{4} + \frac{1}{2} \times (-4) \times \left(\frac{5}{4}\right)^2$$

$$= 21.875 \text{ m}$$

Distance travelled by car in time t = Distance travelled by car in 0.5 s (without retardation)
+ Distance travelled by car in $(t - 0.5)$ s (with retardation)

$$s_c = (20 \times 0.5) + 20\left(\frac{5}{4} - 0.5\right) - \frac{1}{2}\left(\frac{20}{3}\right)\left(\frac{5}{4} - 0.5\right)^2$$

$$= 23.125 \text{ m}$$

\therefore

$$s_c - s_t = 23.125 - 21.875 = 1.250 \text{ m}$$

Therefore, to avoid the bump onto the truck, the car must maintain a distance from the truck more than 1.250 m.

Q. 25 A monkey climbs up a slippery pole for 3 and subsequently slips for 3 . Its velocity at time t is given by $v(t) = 2t(3s - t)$; $0 < t < 3$ and $v(t) = -(t - 3)(6 - t)$ for $3 < t < 6$ s in m/s. It repeats this cycle till it reaches the height of 20 m.

- At what time is its velocity maximum?
- At what time is its average velocity maximum?
- At what time is its acceleration maximum in magnitude?
- How many cycles (counting fractions) are required to reach the top?

Ans. In this problem to calculate maximum velocity we will use $\frac{dv}{dt} = 0$, then the time corresponding to maximum velocity will be obtained.

Given velocity

$$v(t) = 2t(3 - t) = 6t - 2t^2 \quad \dots(i)$$

(a) For maximum velocity $\frac{dv(t)}{dt} = 0$

$$\Rightarrow \frac{d}{dt}(6t - 2t^2) = 0$$

$$\Rightarrow 6 - 4t = 0$$

$$\Rightarrow t = \frac{6}{4} = \frac{3}{2} \text{ s} = 1.5 \text{ s}$$

(b) From Eq. (i) $v = 6t - 2t^2$

$$\Rightarrow \frac{ds}{dt} = 6t - 2t^2$$

$$\Rightarrow ds = (6t - 2t^2) dt$$

where, s is displacement

\therefore Distance travelled in time interval 0 to 3s.

$$\begin{aligned} s &= \int_0^3 (6t - 2t^2) dt \\ &= \left[\frac{6t^2}{2} - \frac{2t^3}{3} \right]_0^3 = \left[3t^2 - \frac{2}{3}t^3 \right]_0^3 \\ &= 3 \times 9 - \frac{2}{3} \times 3 \times 3 \times 3 \\ &= 27 - 18 = 9 \text{ m.} \end{aligned}$$

$$\text{Average velocity} = \frac{\text{Distance travelled}}{\text{Time}}$$

$$= \frac{9}{3} = 3 \text{ m/s}$$

Given,

$$x = 6t - 2t^2$$

$$\Rightarrow 3 = 6t - 2t^2$$

$$\Rightarrow 2t^2 - 6t + 3 = 0$$

$$\begin{aligned} \Rightarrow t &= \frac{6 \pm \sqrt{6^2 - 4 \times 2 \times 3}}{2 \times 2} = \frac{6 \pm \sqrt{36 - 24}}{4} \\ &= \frac{6 \pm \sqrt{12}}{4} = \frac{3 \pm 2\sqrt{3}}{2} \end{aligned}$$

Considering positive sign only

$$t = \frac{3 + 2\sqrt{3}}{2} = \frac{3 + 2 \times 1.732}{2} = \frac{9}{4} \text{ s}$$

(c) In a periodic motion when velocity is zero acceleration will be maximum putting $v = 0$ in Eq. (i)

$$0 = 6t - 2t^2$$

$$\Rightarrow 0 = t(6 - 2t)$$

$$= t \times 2(3 - t) = 0$$

$$\Rightarrow t = 0 \text{ or } 3 \text{ s}$$

(d) Distance covered in 0 to 3s = 9 m

$$\begin{aligned} \text{Distance covered in 3 to 6s} &= \int_3^6 (18 - 9t + t^2) dt \\ &= \left(18t - \frac{9t^2}{2} + \frac{t^3}{3} \right)_3^6 \\ &= 18 \times 6 - \frac{9}{2} \times 6^2 + \frac{6^3}{3} - \left(18 \times 3 - \frac{9 \times 3^2}{2} + \frac{3^3}{3} \right) \\ &= 108 - 9 \times 18 + \frac{6^3}{3} - 18 \times 3 + \frac{9}{2} \times 9 - \frac{27}{3} \\ &= 108 - 18 \times 9 + \frac{216}{3} - 54 + 4.5 \times 9 - 9 = -4.5 \text{ m} \end{aligned}$$

\therefore Total distance travelled in one cycle = $s_1 + s_2 = 9 - 4.5 = 4.5$ m

Number of cycles covered in total distance to be covered = $\frac{20}{4.5} \approx 4.44 \approx 5$.

Q. 26 A man is standing on top of a building 100m high. He throws two balls vertically, one at $t = 0$ and after a time interval (less than 2 seconds). The later ball is thrown at a velocity of half the first. The vertical gap between first and second ball is +15 m at $t = 2$ s. The gap is found to remain constant. Calculate the velocity with which the balls were thrown and the exact time interval between their throw.

Thinking Process

In this question equation of kinematics will be applied with proper sign and to calculate time interval we will take difference of displacements.

Ans. Let the speeds of the two balls (1 and 2) be v_1 and v_2 where

if $v_1 = 2v, v_2 = v$

if y_1 and y_2 and the distance covered by

the balls 1 and 2, respectively, before coming to rest, then

$$y_1 = \frac{v_1^2}{2g} = \frac{4v^2}{2g} \text{ and } y_2 = \frac{v_2^2}{2g} = \frac{v^2}{2g}$$

$$\text{Since, } y_1 - y_2 = 15\text{m, } \frac{4v^2}{2g} - \frac{v^2}{2g} = 15\text{m or } \frac{3v^2}{2g} = 15\text{m}$$

$$\text{or } v^2 = \sqrt{5\text{m} \times (2 \times 10)} \text{ m/s}^2$$

$$\text{or } v = 10 \text{ m/s}$$

Clearly, $v_1 = 20\text{m/s}$ and $v_2 = 10 \text{ m/s}$

$$\text{as } y_1 = \frac{v_1^2}{2g} = \frac{(20\text{m})^2}{2 \times 10\text{m/s}^2} = 20\text{m,}$$

$$y_2 = y_1 - 15\text{m} = 5\text{m}$$

If t_2 is the time taken by the ball 2 to cover

a distance of 5m, then from $y_2 = v_2 t - \frac{1}{2} g t_2^2$

$$5 = 10 t_2 - 5 t_2^2 \text{ or } t_2^2 - 2 t_2 + 1 = 0,$$

where $t_2 = 1\text{s}$

Since t_1 (time taken by ball 1 to cover distance of 20m) is 2s, time interval between the two throws

$$= t_1 - t_2 = 2\text{s} - 1\text{s} = 1\text{s}$$

Note We should be very careful, when we are applying the equation of rectilinear motion.