

# 12

## Linear Programming

### Short Answer Type Questions

**Q. 1** Determine the maximum value of  $Z = 11x + 7y$  subject to the constraints  $2x + y \leq 6$ ,  $x \leq 2$ ,  $x \geq 0$ ,  $y \geq 0$ .

**Thinking Process**

Using constraints, get the corner points for the bounded region and then for each corner point check the corresponding value of  $Z$ .

**Sol.** We have, maximise  $Z = 11x + 7y$  ... (i)  
Subject to the constraints  
 $2x + y \leq 6$  ... (ii)  
 $x \leq 2$  ... (iii)  
 $x \geq 0, y \geq 0$  ... (iv)

We see that, the feasible region as shaded determined by the system of constraints (ii) to (iv) is  $OABC$  and is bounded. So, now we shall use corner point method to determine the maximum value of  $Z$ .

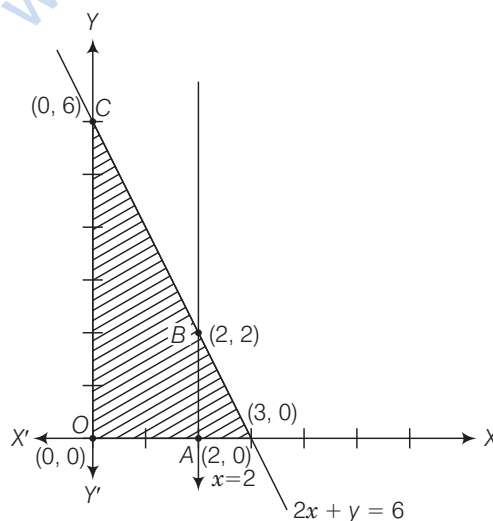

Corner points	Corresponding value of $Z$
(0, 0)	0
(2, 0)	22
(2, 2)	36
(0, 6)	42 ← Maximum

Hence, the maximum value of  $Z$  is 42 at (0, 6).

**Q. 2** Maximise  $Z = 3x + 4y$ , subject to the constraints  $x + y \leq 1$ ,  $x \geq 0$ ,  $y \geq 0$ .

**Sol.** Maximise  $Z = 3x + 4y$ , Subject to the constraints  
 $x + y \leq 1$ ,  $x \geq 0$ ,  $y \geq 0$ .

The shaded region shown in the figure as  $OAB$  is bounded and the coordinates of corner points  $O$ ,  $A$  and  $B$  are (0, 0), (1, 0) and (0, 1), respectively.

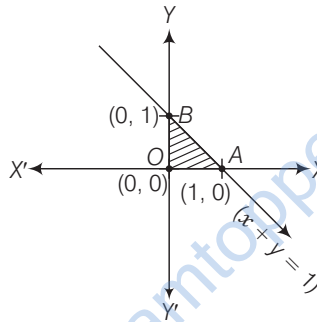

Corner points	Corresponding value of $Z$
(0, 0)	0
(1, 0)	3
(0, 1)	4 ← Maximum

Hence, the maximum value of  $Z$  is 4 at (0, 1).

**Q. 3** Maximise the function  $Z = 11x + 7y$ , subject to the constraints  $x \leq 3$ ,  $y \leq 2$ ,  $x \geq 0$  and  $y \geq 0$ .

**Sol.** Maximise  $Z = 11x + 7y$ , subject to the constraints  $x \leq 3$ ,  $y \leq 2$ ,  $x \geq 0$ ,  $y \geq 0$ .

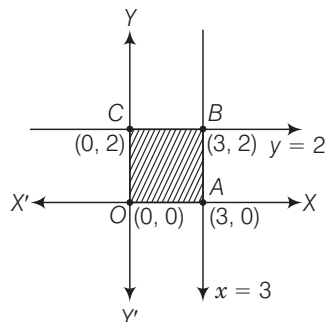

The shaded region as shown in the figure as  $OABC$  is bounded and the coordinates of corner points are (0, 0), (3, 0), (3, 2) and (0, 2), respectively.

Corner points	Corresponding value of Z
(0, 0)	0
(3, 0)	33
(3, 2)	47 ← Maximum
(0, 2)	14

Hence, Z is maximum at (3, 2) and its maximum value is 47.

**Q. 4** Minimise  $Z = 13x - 15y$  subject to the constraints  $x + y \leq 7$ ,  $2x - 3y + 6 \geq 0$ ,  $x \geq 0$  and  $y \geq 0$ .

**Sol.** Minimise  $Z = 13x - 15y$  subject to the constraints  $x + y \leq 7$ ,  $2x - 3y + 6 \geq 0$ ,  $x \geq 0$ ,  $y \geq 0$ .

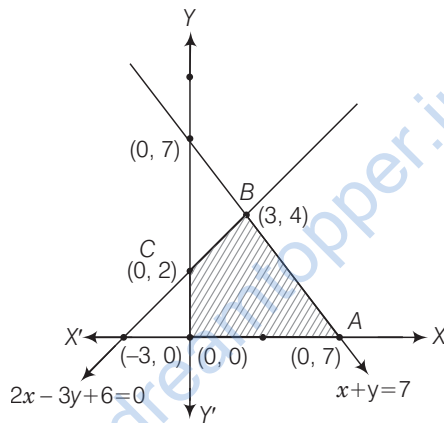

Shaded region shown as OABC is bounded and coordinates of its corner points are (0, 0), (7, 0), (3, 4) and (0, 2), respectively.

Corner points	Corresponding value of Z
(0, 0)	0
(7, 0)	91
(3, 4)	-21
(0, 2)	-30 ← Minimum

Hence, the minimum value of Z is (-30) at (0, 2).

**Q. 5** Determine the maximum value of  $Z = 3x + 4y$ , if the feasible region (shaded) for a LPP is shown in following figure.

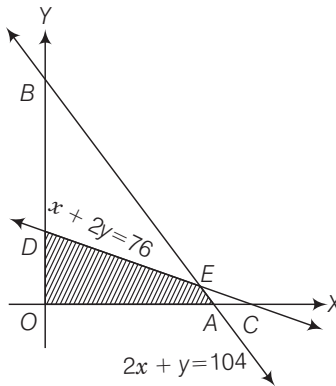

**Sol.** As clear from the graph, corner points are  $O, A, E$  and  $D$  with coordinates  $(0, 0), (52, 0), (144, 16)$  and  $(0, 38)$ , respectively. Also, given region is bounded.

Here,  
 $\therefore$   
 $\Rightarrow$   
 $\Rightarrow$

$$Z = 3x + 4y$$

$$2x + y = 104 \text{ and } 2x + 4y = 152$$

$$-3y = -48$$

$$y = 16 \text{ and } x = 44$$

Corner points	Corresponding value of $Z$
$(0, 0)$	0
$(52, 0)$	156
$(44, 16)$	196 ← Maximum
$(0, 38)$	152

Hence,  $Z$  is at  $(44, 16)$  is maximum and its maximum value is 196.

**Q. 6** Feasible region (shaded) for a LPP is shown in following figure. Maximise  $Z = 5x + 7y$ .

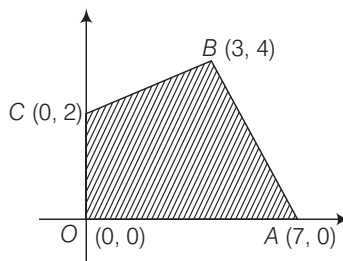

**Sol.** The shaded region is bounded and has coordinates of corner points as  $(0, 0), (7, 0), (3, 4)$  and  $(0, 2)$ . Also,  $Z = 5x + 7y$ .

Corner points	Corresponding value of $Z$
$(0, 0)$	0
$(7, 0)$	35
$(3, 4)$	43 ← Maximum
$(0, 2)$	14

Hence, the maximum value of  $Z$  is 43 at  $(3, 4)$ .

**Q. 7** The feasible region for a LPP is shown in following figure. Find the minimum value of  $Z = 11x + 7y$ .

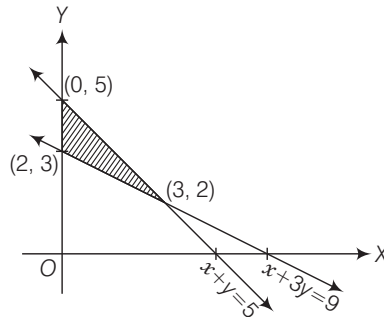

**Sol.** From the figure, it is clear that feasible region is bounded with coordinates of corner points as  $(0, 3)$ ,  $(3, 2)$  and  $(0, 5)$ . Here,  $Z = 11x + 7y$ .

$$\because x + 3y = 9 \text{ and } x + y = 5$$

$$\Rightarrow 2y = 4$$

$$\because y = 2 \text{ and } x = 3$$

So, intersection points of  $x + y = 5$  and  $x + 3y = 9$  is  $(3, 2)$ .

Corner points	Corresponding value of Z
$(0, 3)$	21 ← Minimum
$(3, 2)$	47
$(0, 5)$	35

Hence, the minimum value of  $Z$  is 21 at  $(0, 3)$ .

**Q. 8** Refer to question 7 above. Find the maximum value of  $Z$ .

**Sol.** From question 7, above, it is clear that  $Z$  is maximum at  $(3, 2)$  and its maximum value is 47.

**Q. 9** The feasible region for a LPP is shown in the following figure. Evaluate  $Z = 4x + y$  at each of the corner points of this region. Find the minimum value of  $Z$ , if it exists.

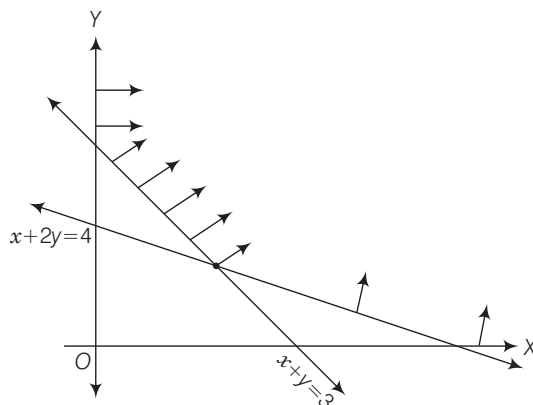

**Sol.** From the shaded region, it is clear that feasible region is unbounded with the corner points  $A(4, 0)$ ,  $B(2, 1)$  and  $C(0, 3)$ .

Also, we have

$$Z = 4x + y.$$

[since,  $x + 2y = 4$  and  $x + y = 3 \Rightarrow y = 1$  and  $x = 2$ ]

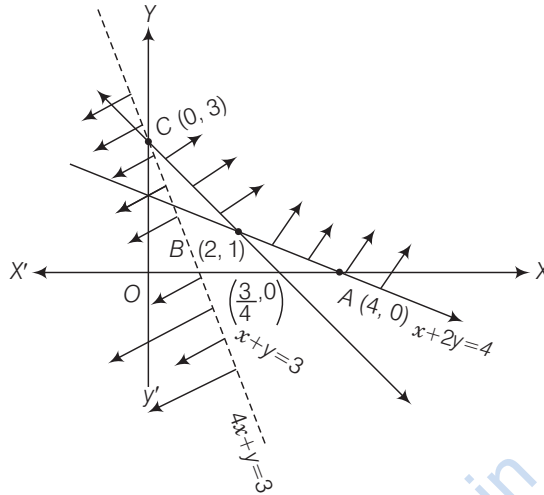

Corner points	Corresponding value of Z
(4, 0)	16
(2, 1)	9
(0, 3)	3 ← Minimum

Now, we see that 3 is the smallest value of Z at the corner point (0, 3). Note that here we see that, the region is unbounded, therefore 3 may or may not be the minimum value of Z.

To decide this issue, we graph the inequality  $4x + y < 3$  and check whether the resulting open half plane has no point in common with feasible region otherwise, Z has no minimum value.

From the shown graph above, it is clear that there is no point in common with feasible region and hence Z has minimum value 3 at (0, 3).

**Q. 10** In following figure, the feasible region (shaded) for a LPP is shown. Determine the maximum and minimum value of  $Z = x + 2y$ .

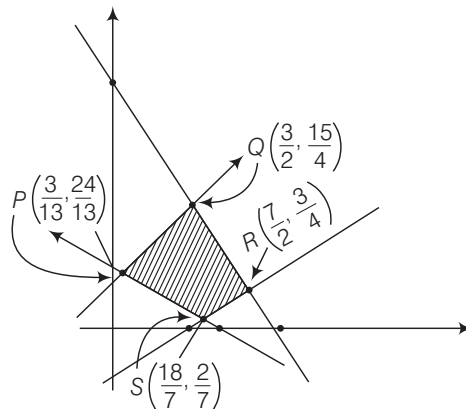

**Sol.** From the shaded bounded region, it is clear that the coordinates of corner points are  $\left(\frac{3}{13}, \frac{24}{13}\right)$ ,  $\left(\frac{18}{7}, \frac{2}{7}\right)$ ,  $\left(\frac{7}{2}, \frac{3}{4}\right)$  and  $\left(\frac{3}{2}, \frac{15}{4}\right)$ .

Also, we have to determine maximum and minimum value of  $Z = x + 2y$ .

Corner points	Corresponding value of $Z$
$\left(\frac{3}{13}, \frac{24}{13}\right)$	$\frac{3}{13} + \frac{48}{13} = \frac{51}{13} = 3\frac{12}{13}$
$\left(\frac{18}{7}, \frac{2}{7}\right)$	$\frac{18}{7} + \frac{4}{7} = \frac{22}{7} = 3\frac{1}{7}$ Minimum
$\left(\frac{7}{2}, \frac{3}{4}\right)$	$\frac{7}{2} + \frac{6}{4} = \frac{20}{4} = 5$
$\left(\frac{3}{2}, \frac{15}{4}\right)$	$\frac{3}{2} + \frac{30}{4} = \frac{36}{4} = 9$ Maximum

Hence, the maximum and minimum values of  $Z$  are 9 and  $3\frac{1}{7}$ , respectively.

- Q. 11** A manufacturer of electronic circuits has a stock of 200 resistors, 120 transistors and 150 capacitors and is required to produce two types of circuits A and B. Type A requires 20 resistors, 10 transistors and 10 capacitors. Type B requires 10 resistors, 20 transistors and 30 capacitors. If the profit on type A circuit is ₹ 50 and that on type B circuit is ₹ 60, formulate this problem as a LPP, so that the manufacturer can maximise his profit.

**Thinking Process**

For maximising the profit, use resistor constraint, transistor constraint, capacitor constraint and non-negative constraint.

- Sol.** Let the manufacturer produces  $x$  units of type A circuits and  $y$  units of type B circuits. Form the given information, we have following corresponding constraint table.

	Type A ( $x$ )	Type B ( $y$ )	Maximum stock
Resistors	20	10	200
Transistors	10	20	120
Capacitors	10	30	150
<b>Profit</b>	<b>₹ 50</b>	<b>₹ 60</b>	

Thus, we see that total profit  $Z = 50x + 60y$  (in ₹).

Now, we have the following mathematical model for the given problem.

Maximise  $Z = 50x + 60y$  ... (i)

Subject to the constraints.

$20x + 10y \leq 200$  [resistors constraint]

$\Rightarrow 2x + y \leq 20$  ... (ii)

and  $10x + 20y \leq 120$  [transistor constraint]

$\Rightarrow x + 2y \leq 12$  ... (iii)

and  $10x + 30y \leq 150$  [capacitor constraint]

$\Rightarrow x + 3y \leq 15$  ... (iv)

and  $x \geq 0, y \geq 0$  [non-negative constraint] ... (v)

So, maximise  $Z = 50x + 60y$ , subject to  $2x + y \leq 20, x + 2y \leq 12, x + 3y \leq 15, x \geq 0, y \geq 0$ .

**Q. 12** A firm has to transport 1200 packages using large vans which can carry 200 packages each and small vans which can take 80 packages each. The cost for engaging each large van is ₹ 400 and each small van is ₹ 200. Not more than ₹ 3000 is to be spent on the job and the number of large vans cannot exceed the number of small vans. Formulate this problem as a LPP given that the objective is to minimise cost.

**Sol.** Let the firm has  $x$  number of large vans and  $y$  number of small vans. From the given information, we have following corresponding constraint table.

	Large vans ( $x$ )	Small vans ( $y$ )	Maximum / Minimum
Packages	200	80	1200
Cost	400	200	3000

Thus, we see that objective function for minimum cost is  $Z = 400x + 200y$ .

Subject to constraints

$$\begin{aligned} & 200x + 80y \geq 1200 && \text{[package constraint]} \\ \Rightarrow & 5x + 2y \geq 30 && \dots(i) \\ \text{and} & && \\ & 400x + 200y \leq 3000 && \text{[cost constraint]} \\ \Rightarrow & 2x + y \leq 15 && \dots(ii) \\ \text{and} & && \\ & x \leq y && \text{[van constraint] } \dots(iii) \\ \text{and} & && \\ & x \geq 0, y \geq 0 && \text{[non-negative constraints] } \dots(iv) \end{aligned}$$

Thus, required LPP to minimise cost is minimise  $Z = 400x + 200y$ , subject to  $5x + 2y \geq 30$ .

$$\begin{aligned} & 2x + y \leq 15 \\ & x \leq y \\ & x \geq 0, y \geq 0 \end{aligned}$$

**Q. 13** A company manufactures two types of screws  $A$  and  $B$ . All the screws have to pass through a threading machine and a slotting machine. A box of type  $A$  screws requires 2 min on the threading machine and 3 min on the slotting machine. A box of type  $B$  screws requires 8 min on the threading machine and 2 min on the slotting machine. In a week, each machine is available for 60 h. On selling these screws, the company gets a profit of ₹ 100 per box on type  $A$  screws and ₹ 170 per box on type  $B$  screws.

Formulate this problem as a LPP given that the objective is to maximise profit.

**Sol.** Let the company manufactures  $x$  boxes of type  $A$  screws and  $y$  boxes of type  $B$  screws. From the given information, we have following corresponding constraint table

	Type A ( $x$ )	Type B ( $y$ )	Maximum time available on each machine in a week
Time required for screws on threading machine	2	8	$60 \times 60$ (min)
Time required for screws on slotting machine	3	2	$60 \times 60$ (min)
<b>Profit</b>	₹ 100	₹ 170	



Thus, we see that objective function for maximum profit is  $Z = 100x + 170y$ .

Subject to constraints

$$\Rightarrow \begin{array}{l} 2x + 8y \leq 60 \times 60 \quad [\text{time constraint for threading machine}] \\ x + 4y \leq 1800 \quad \dots(i) \end{array}$$

$$\text{and} \quad \begin{array}{l} 3x + 2y \leq 60 \times 60 \quad [\text{time constraint for slotting machine}] \\ 3x + 2y \leq 3600 \quad \dots(ii) \end{array}$$

$$\Rightarrow \quad \begin{array}{l} 3x + 2y \leq 3600 \quad \dots(ii) \\ \text{Also,} \quad x \geq 0, y \geq 0 \quad [\text{non-negative constraints}] \dots(iii) \end{array}$$

$\therefore$  Required LPP is,

$$\text{Maximise} \quad Z = 100x + 170y$$

Subject to constraints  $x + 4y \leq 1800, 3x + 2y \leq 3600, x \geq 0, y \geq 0$ .

**Q. 14** A company manufactures two types of sweaters type A and type B. It costs ₹ 360 to make a type A sweater and ₹ 120 to make a type B sweater. The company can make atmost 300 sweaters and spend atmost ₹ 72000 a day. The number of sweaters of type B cannot exceed the number of sweaters of type A by more than 100. The company makes a profit of ₹ 200 for each sweater of type A and ₹ 120 for every sweater of type B.

Formulate this problem as a LPP to maximise the profit to the company.

**Sol.** Let the company manufactures  $x$  number of type A sweaters and  $y$  number of type B sweaters.

From the given information we see that cost to make a type A sweater is ₹360 and cost to make a type B sweater is ₹ 120.

Also, the company spend atmost ₹ 72000 a day.

$$\therefore \quad 360x + 120y \leq 72000$$

$$\Rightarrow \quad 3x + y \leq 600 \quad \dots(i)$$

Also, company can make atmost 300 sweaters.

$$\therefore \quad x + y \leq 300 \quad \dots(ii)$$

Further, the number of sweaters of type B cannot exceed the number of sweaters of type A by more than 100 i.e.,

$$x + 100 \geq y$$

$$\Rightarrow \quad x - y \geq -100 \quad \dots(iii)$$

Also, we have non-negative constraints for  $x$  and  $y$  i.e.,  $x \geq 0, y \geq 0$   $\dots(iv)$

Hence, the company makes a profit of ₹200 for each sweater of type A and ₹120 for each sweater of type B i.e.,

$$\text{Profit (Z)} = 200x + 120y$$

Thus, the required LPP to maximise the profit is

Maximise  $Z = 200x + 120y$  is subject to constraints.

$$3x + y \leq 600$$

$$x + y \leq 300$$

$$x - y \geq -100$$

$$x \geq 0, y \geq 0$$

**Q. 15** A man rides his motorcycle at the speed of 50 km/h. He has to spend ₹ 2 per km on petrol. If he rides it at a faster speed of 80 km/h, the petrol cost increases to ₹ 3 per km. He has atmost ₹ 120 to spend on petrol and one hour's time. He wishes to find the maximum distance that he can travel. Express this problem as a linear programming problem.

**Sol.** Let the man rides to his motorcycle to a distance  $x$  km at the speed of 50 km/h and to a distance  $y$  km at the speed of 80 km/h.

Therefore, cost on petrol is  $2x + 3y$ .

Since, he has to spend ₹ 120 atmost on petrol.

$$\therefore 2x + 3y \leq 120 \quad \dots(i)$$

Also, he has atmost one hour's time.

$$\therefore \frac{x}{50} + \frac{y}{80} \leq 1$$

$$\Rightarrow 8x + 5y \leq 400 \quad \dots(ii)$$

Also, we have  $x \geq 0, y \geq 0$  [non-negative constraints]

Thus, required LPP to travel maximum distance by him is

Maximise  $Z = x + y$ , subject to  $2x + 3y \leq 120, 8x + 5y \leq 400, x \geq 0, y \geq 0$

**Q. 16** Refer to question 11. How many of circuits of type A and of type B, should be produced by the manufacturer, so as to maximise his profit? Determine the maximum profit.

**Thinking Process**

Using the constraints draw the graph to get the corner points and find the maximum value of possible corner points (as asked).

**Sol.** Referring to solution 11, we have

Maximise  $Z = 50x + 60y$ , subject to

$$2x + y \leq 20, x + 2y \leq 12, x + 3y \leq 15, x \geq 0, y \geq 0$$

From the shaded region it is clear that the feasible region determined by the system of constraints is  $OABCD$  and is bounded and the coordinates of corner points are  $(0, 0)$ ,

$(10, 0)$ ,  $(\frac{28}{3}, \frac{4}{3})$ ,  $(6, 3)$  and  $(0, 5)$ , respectively.

$$\begin{aligned} \text{[since, } x + 2y = 12 \text{ and } 2x + y = 20 \Rightarrow x = \frac{28}{3}, y = \frac{4}{3} \text{ and } x + 3y = 15 \\ \text{and } x + 2y = 12 \Rightarrow y = 3 \text{ and } x = 6] \end{aligned}$$

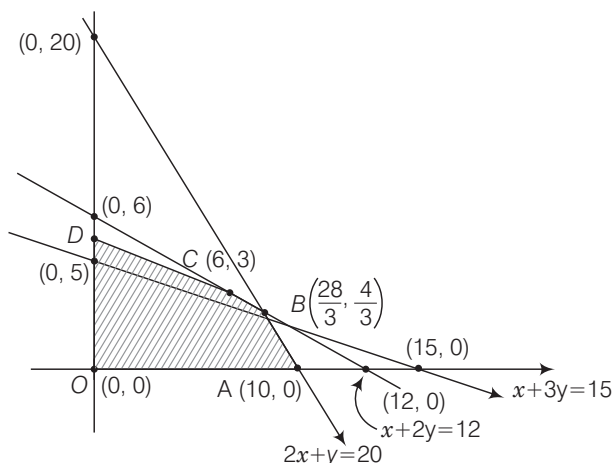

Corner points	Corresponding value of $Z = 50x + 60y$
(0, 0)	0
(10, 0)	500
$\left(\frac{28}{3}, \frac{4}{3}\right)$	$\frac{1400}{3} + \frac{240}{3} = \frac{1640}{3} = 546.66 \leftarrow \text{Maximum}$
(6, 3)	480
(0, 5)	300

Since, the manufacturer is required to produce two types of circuits A and B and it is clear that parts of resistor, transistor and capacitor cannot be in fraction, so the required maximum profit is 480 where circuits of type A is 6 and circuits of type B is 3.

**Q. 17** Refer to question 12. What will be the minimum cost?

**Sol.** Referring to solution 12, we have minimise  $Z = 400x + 200y$ , subject to  $5x + 2y \geq 30$ ,  $2x + y \leq 15$ ,  $x \leq y$ ,  $x \geq 0$ ,  $y \geq 0$ .

On solving  $x - y = 0$  and  $5x + 2y = 30$ , we get

$$y = \frac{30}{7}, x = \frac{30}{7}$$

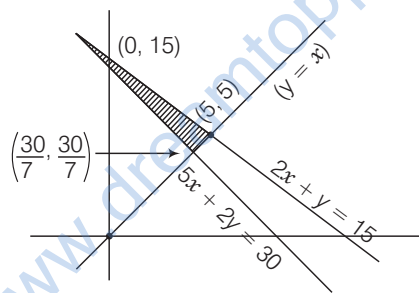

On solving  $x - y = 0$  and  $2x + y = 15$ , we get  $x = 5$ ,  $y = 5$

So, from the shaded feasible region it is clear that coordinates of corner points are (0, 15), (5, 5) and  $\left(\frac{30}{7}, \frac{30}{7}\right)$ .

Corner points	Corresponding value of $Z = 400x + 200y$
(0, 15)	3000
(5, 5)	3000
$\left(\frac{30}{7}, \frac{30}{7}\right)$	$400 \times \frac{30}{7} + 200 \times \frac{30}{7} = \frac{18000}{7}$ $= 2571.43 \leftarrow \text{Minimum}$

Hence, the minimum cost is ₹ 2571.43.

**Q. 18** Refer to question 13. Solve the linear programming problem and determine the maximum profit to the manufacturer.

**Sol.** Referring to solution 13, we have  
 Maximise  $Z = 100x + 170y$  subject to

$$3x + 2y \leq 3600, x + 4y \leq 1800, x \geq 0, y \geq 0$$

From the shaded feasible region it is clear that the coordinates of corner points are  $(0, 0)$ ,  $(1200, 0)$ ,  $(1080, 180)$  and  $(0, 450)$ .

On solving  $x + 4y = 1800$  and  $3x + 2y = 3600$ , we get  $x = 1080$  and  $y = 180$

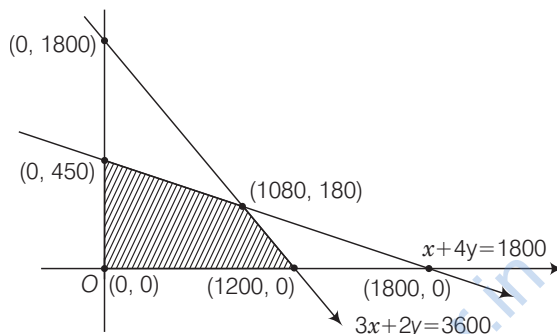

Corner points	Corresponding value of $Z = 100x + 170y$
$(0, 0)$	0
$(1200, 0)$	$1200 \times 100 = 120000$
$(1080, 180)$	$100 \times 1080 + 170 \times 180 = 138600 \leftarrow \text{Maximum}$
$(0, 450)$	$0 + 170 \times 450 = 76500$

Hence, the maximum profit to the manufacturer is 138600.

**Q. 19** Refer to question 14. How many sweaters of each type should the company make in a day to get a maximum profit? What is the maximum profit?

**Sol.** Referring to solution 14, we have maximise  $Z = 200x + 120y$   
 subject to  $x + y \leq 300, 3x + y \leq 600, x - y \geq -100, x \geq 0, y \geq 0$ .

On solving  $x + y = 300$  and  $3x + y = 600$ , we get

$$x = 150, y = 150$$

On solving  $x - y = -100$  and  $x + y = 300$ , we get

$$x = 100, y = 200$$

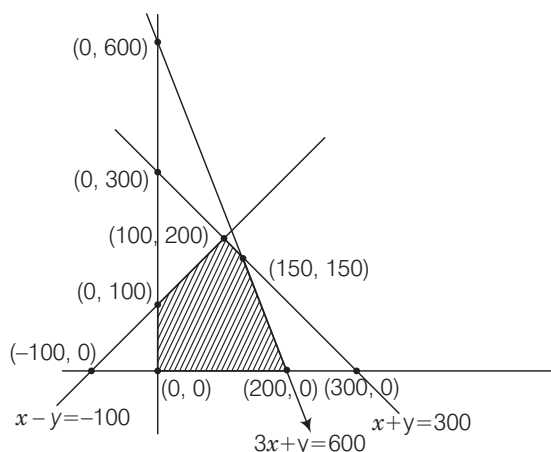

From the shaded feasible region it is clear that coordinates of corner points are (0, 0), (200, 0), (150, 150), (100, 200) and (0, 100).

Corner points	Corresponding value of $Z = 200x + 120y$
(0, 0)	0
(200, 0)	40000
(150, 150)	$150 \times 200 + 120 \times 150 = 48000$ ← Maximum
(100, 200)	$100 \times 200 + 120 \times 200 = 44000$
(0, 100)	$120 \times 100 = 12000$

Hence, 150 sweaters of each type made by company and maximum profit = ₹ 48000.

**Q. 20** Refer to question 15. Determine the maximum distance that the man can travel.

**Sol.** Referring to solution 15, we have

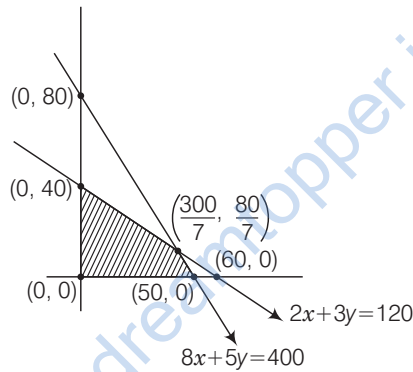

Maximise  $Z = x + y$ , subject to  
 $2x + 3y \leq 120$ ,  $8x + 5y \leq 400$ ,  $x \geq 0, y \geq 0$

On solving, we get

$8x + 5y = 400$  and  $2x + 3y = 120$ , we get

$$x = \frac{300}{7}, y = \frac{80}{7}$$

From the shaded feasible region, it is clear that coordinates of corner points are (0, 0), (50, 0),  $\left(\frac{300}{7}, \frac{80}{7}\right)$  and (0, 40).

Corner points	Corresponding value of $Z = x + y$
(0, 0)	0
(50, 0)	50
$\frac{300}{7}, \frac{80}{7}$	$\frac{380}{7} = 54\frac{2}{7}$ km ← Maximum
(0, 40)	40

Hence, the maximum distance that the man can travel is  $54\frac{2}{7}$  km.

**Q. 21** Maximise  $Z = x + y$  subject to  $x + 4y \leq 8$ ,  $2x + 3y \leq 12$ ,  $3x + y \leq 9$ ,  $x \geq 0$  and  $y \geq 0$ .

**Sol.** Here, the given LPP is,

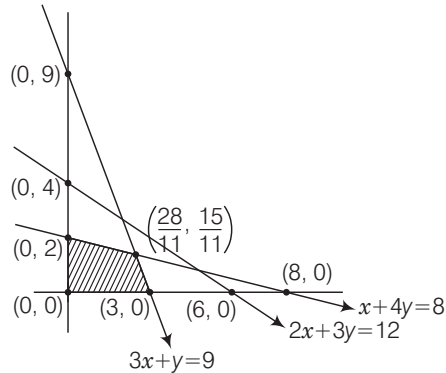

Maximise  $Z = x + y$  subject to,

$$x + 4y \leq 8, 2x + 3y \leq 12, 3x + y \leq 9, x \geq 0, y \geq 0.$$

On solving  $x + 4y = 8$  and  $3x + y = 9$ , we get

$$x = \frac{28}{11}, y = \frac{15}{11}.$$

From the feasible region, it is clear that coordinates of corner points are  $(0, 0)$ ,  $(3, 0)$ ,  $(\frac{28}{11}, \frac{15}{11})$  and  $(0, 2)$ .

Corner points	Value of $Z = x + y$
$(0, 0)$	0
$(3, 0)$	3
$(\frac{28}{11}, \frac{15}{11})$	$\frac{43}{11} = 3\frac{10}{11}$ ← Maximum
$(0, 2)$	2

Hence, the maximum value is  $3\frac{10}{11}$ .

**Q. 22** A manufacturer produces two models of bikes-model  $X$  and model  $Y$ . Model  $X$  takes a 6 man-hours to make per unit, while model  $Y$  takes 10 man hours per unit. There is a total of 450 man-hour available per week. Handling and marketing costs are ₹ 2000 and ₹ 1000 per unit for models  $X$  and  $Y$ , respectively. The total funds available for these purposes are ₹ 80000 per week. Profits per unit for models  $X$  and  $Y$  are ₹ 1000 and ₹ 500, respectively. How many bikes of each model should the manufacturer produce, so as to yield a maximum profit? Find the maximum profit.

💡 **Thinking Process**

First check whether the drawn graph (by using constraints) gives bounded region or not and then get the maximised profit on corresponding corner points.

**Sol.** Let the manufacturer produces  $x$  number of models  $X$  and  $y$  number of model  $Y$  bikes. Model  $X$  takes a 6 man-hours to make per unit and model  $Y$  takes a 10 man-hours to make per unit.

There is total of 450 man-hour available per week.

$$\therefore 6x + 10y \leq 450$$

$$\Rightarrow 3x + 5y \leq 225 \quad \dots(i)$$

For models X and Y, handling and marketing costs are ₹ 2000 and ₹1000, respectively, total funds available for these purposes are ₹ 80000 per week.

$$\therefore 2000x + 1000y \leq 80000$$

$$\Rightarrow 2x + y \leq 80 \quad \dots(ii)$$

$$\text{Also, } x \geq 0, y \geq 0$$

Hence, the profits per unit for models X and Y are ₹ 1000 and ₹ 500, respectively.

$\therefore$  Required LPP is

$$\text{Maximise } Z = 1000x + 500y$$

$$\text{Subject to, } 3x + 5y \leq 225, 2x + y \leq 80, x \geq 0, y \geq 0$$

From the shaded feasible region, it is clear that coordinates of corner points are (0, 0), (40, 0), (25, 30) and (0, 45).

On solving  $3x + 5y = 225$  and  $2x + y = 80$ , we get

$$x = 25, y = 30$$

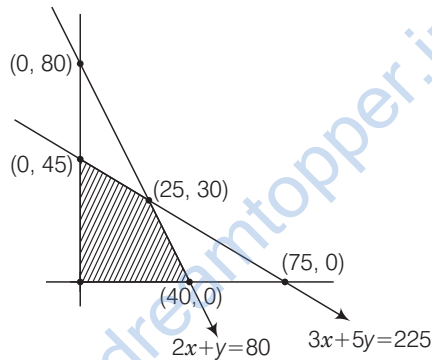

Corner points	Value of $Z = 1000x + 500y$
(0, 0)	0
(40, 0)	40000 ← Maximum
(25, 30)	25000 + 15000 = 40000 ← Maximum
(0, 45)	22500

So, the manufacturer should produce 25 bikes of model X and 30 bikes of model Y to get a maximum profit of ₹ 40000.

Since, in question it is asked that each model bikes should be produced.

**Q. 23** In order to supplement daily diet, a person wishes to take some X and some wishes Y tablets. The contents of iron, calcium and vitamins in X and Y (in mg/tablet) are given as below

Tablets	Iron	Calcium	Vitamin
X	6	3	2
Y	2	3	4

The person needs atleast 18 mg of iron, 21 mg of calcium and 16 mg of vitamins. The price of each tablet of X and Y is ₹ 2 and ₹1, respectively. How many tablets of each should the person take in order to satisfy the above requirement at the minimum cost?

**Sol.** Let the person takes  $x$  units of tablet X and  $y$  units of tablet Y.

So, from the given information, we have

$$6x + 2y \geq 18 \Rightarrow 3x + y \geq 9 \quad \dots(i)$$

$$3x + 3y \geq 21 \Rightarrow x + y \geq 7 \quad \dots(ii)$$

and  $2x + 4y \geq 16 \Rightarrow x + 2y \geq 8 \quad \dots(iii)$

Also, we know that here,  $x \geq 0, y \geq 0 \quad \dots(iv)$

The price of each tablet of X and Y is ₹ 2 and ₹ 1, respectively.

So, the corresponding LPP is minimise  $Z = 2x + y$ , subject to  $3x + y \geq 9, x + y \geq 7, x + 2y \geq 8, x \geq 0, y \geq 0$

From the shaded graph, we see that for the shown unbounded region, we have coordinates of corner points A, B, C and D as (8, 0), (6, 1), (1, 6), and (0, 9), respectively.

[on solving  $x + 2y = 8$  and  $x + y = 7$ , we get  $x = 6, y = 1$  and on solving  $3x + y = 9$  and  $x + y = 7$ , we get  $x = 1, y = 6$ ]

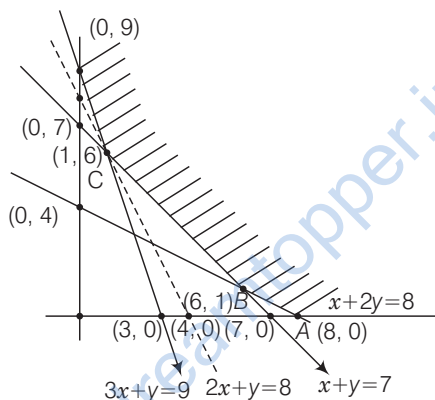

Corner points	Value of $Z = 2x + y$
(8, 0)	16
(6, 1)	13
(1, 6)	8 ← Minimum
(0, 9)	9

Thus, we see that 8 is the minimum value of  $Z$  at the corner point (1, 6). Here, we see that the feasible region is unbounded. Therefore, 8 may or may not be the minimum value of  $Z$ . To decide this issue, we graph the inequality

$$2x + y < 8 \quad \dots(v)$$

and check whether the resulting open half has points in common with feasible region or not. If it has common point, then 8 will not be the minimum value of  $Z$ , otherwise 8 will be the minimum value of  $Z$ .

Thus, from the graph it is clear that, it has no common point.

Therefore,  $Z = 2x + y$  has 8 as minimum value subject to the given constraints.

Hence, the person should take 1 unit of X tablet and 6 units of Y tablets to satisfy the given requirements and at the minimum cost of ₹ 8.



**Q. 24** A company makes 3 model of calculators;  $A$ ,  $B$  and  $C$  at factory I and factory II. The company has orders for atleast 6400 calculators of model  $A$ , 4000 calculators of model  $B$  and 4800 calculators of model  $C$ . At factory I, 50 calculators of model  $A$ , 50 of model  $B$  and 30 of model  $C$  are made everyday; at factory II, 40 calculators of model  $A$ , 20 of model  $B$  and 40 of model  $C$  are made everyday. It costs ₹ 12000 and ₹ 15000 each day to operate factory I and II, respectively. Find the number of days each factory should operate to minimise the operating costs and still meet the demand.

**Sol.** Let the factory I operate for  $x$  days and the factory II operate for  $y$  days.

At factory I, 50 calculators of model  $A$  and at factory II, 40 calculators of model  $A$  are made everyday. Also, company has ordered for atleast 6400 calculators of model  $A$ .

$$\therefore 50x + 40y \geq 6400 \Rightarrow 5x + 4y \geq 640 \quad \dots(i)$$

Also, at factory I, 50 calculators of model  $B$  and at factory II, 20 calculators of modal  $B$  are made everyday.

Since, the company has ordered atleast 4000 calculators of model  $B$ .

$$\therefore 50x + 20y \geq 4000 \Rightarrow 5x + 2y \geq 400 \quad \dots(ii)$$

Similarly, for model  $C$ ,

$$30x + 40y \geq 4800$$

$$\Rightarrow 3x + 4y \geq 480 \quad \dots(iii)$$

$$\text{Also, } x \geq 0, y \geq 0 \quad \dots(iv)$$

[since,  $x$  and  $y$  are non-negative]

It costs ₹ 12000 and ₹ 15000 each day to operate factories I and II, respectively.

$\therefore$  Corresponding LPP is,

Minimise  $Z = 12000x + 15000y$ , subject to

$$5x + 4y \geq 640$$

$$5x + 2y \geq 400$$

$$3x + 4y \geq 480$$

$$x \geq 0, y \geq 0$$

On solving  $3x + 4y = 480$  and  $5x + 4y = 640$ , we get  $x = 80$ ,  $y = 60$ .

On solving  $5x + 4y = 640$  and  $5x + 2y = 400$ , we get  $x = 32$ ,  $y = 120$

Thus, from the graph, it is clear that feasible region is unbounded and the coordinates of corner points  $A$ ,  $B$ ,  $C$  and  $D$  are  $(160, 0)$ ,  $(80, 60)$ ,  $(32, 120)$  and  $(0, 200)$ , respectively.

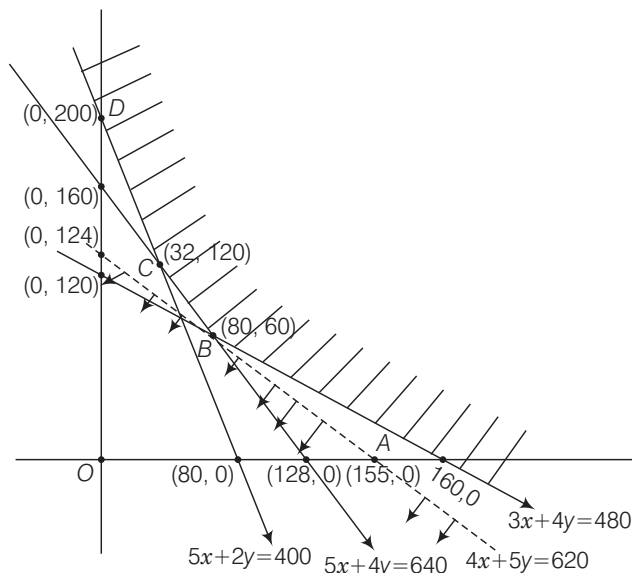

Corner points	Value of $Z = 12000x + 15000y$
(160, 0)	$160 \times 12000 = 1920000$
(80, 60)	$(80 \times 12 + 60 \times 15) \times 1000 = 1860000 \leftarrow \text{Minimum}$
(32, 120)	$(32 \times 12 + 120 \times 15) \times 1000 = 2184000$
(0, 200)	$0 + 200 \times 15000 = 3000000$

From the above table, it is clear that for given unbounded region the minimum value of  $Z$  may or may not be 1860000.

Now, for deciding this, we graph the inequality

$$12000x + 15000y < 1860000$$

$\Rightarrow$

$$4x + 5y < 620$$

and check whether the resulting open half plane has points in common with feasible region or not.

Thus, as shown in the figure, it has no common points so,  $Z = 12000x + 15000y$  has minimum value 1860000.

So, number of days factory I should be operated is 80 and number of days factory II should be operated is 60 for the minimum cost and satisfying the given constraints.

**Q. 25** Maximise and minimise  $Z = 3x - 4y$  subject to  $x - 2y \leq 0$ ,  $-3x + y \leq 4$ ,  $x - y \leq 6$  and  $x, y \geq 0$ .

**Sol.** Given LPP is,

maximise and minimise  $Z = 3x - 4y$  subject to  $x - 2y \leq 0$ ,  $-3x + y \leq 4$ ,  $x - y \leq 6$ ,  $x, y \geq 0$ .

[on solving  $x - y = 6$  and  $x - 2y = 0$ , we get  $x = 12$ ,  $y = 6$ ]

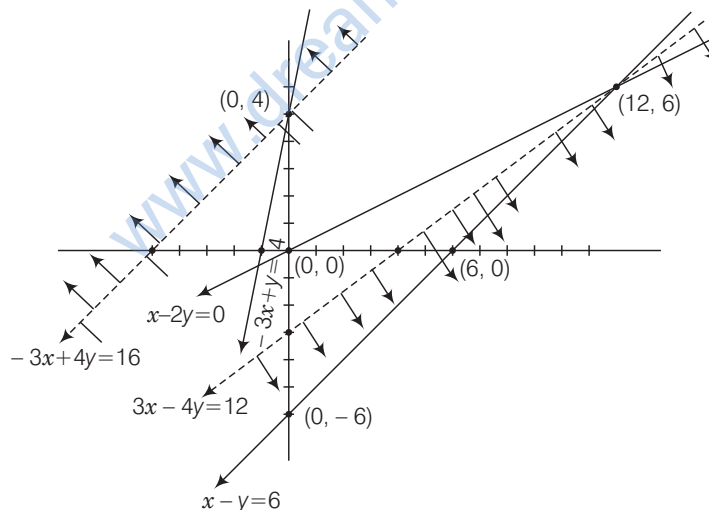

From the shown graph, for the feasible region, we see that it is unbounded and coordinates of corner points are (0, 0), (12, 6) and (0, 4).

Corner points	Corresponding value of $Z = 3x - 4y$
(0, 0)	0
(0, 4)	$-16 \leftarrow \text{Minimum}$
(12, 6)	$12 \leftarrow \text{Maximum}$

For given unbounded region the minimum value of  $Z$  may or may not be  $-16$ . So, for deciding this, we graph the inequality.

$$3x - 4y < -16$$

and check whether the resulting open half plane has common points with feasible region or not.

Thus, from the figure it shows it has common points with feasible region, so it does not have any minimum value.

Also, similarly for maximum value, we graph the inequality  $3x - 4y > 12$

and see that resulting open half plane has no common points with the feasible region and hence maximum value 12 exist for  $Z = 3x - 4y$ .

## Objective Type Questions

**Q. 26** The corner points of the feasible region determined by the system of linear constraints are  $(0, 0)$ ,  $(0, 40)$ ,  $(20, 40)$ ,  $(60, 20)$ ,  $(60, 0)$ . The objective function is  $Z = 4x + 3y$ . Compare the quantity in column A and column B.

Column A	Column B
Maximum of $Z$	325

- (a) The quantity in column A is greater  
 (b) The quantity in column B is greater  
 (c) The two quantities are equal  
 (d) The relationship cannot be determined on the basis of the information supplied.

**Sol. (b)**

Corner points	Corresponding value of $Z = 4x + 3y$
$(0, 0)$	0
$(0, 40)$	120
$(20, 40)$	200
$(60, 20)$	300 ← Maximum
$(60, 0)$	240

Hence, maximum value of  $Z = 300 < 325$

So, the quantity in column B is greater.

**Q. 27** The feasible solution for a LPP is shown in following figure. Let  $Z = 3x - 4y$  be the objective function. Minimum of  $Z$  occurs at

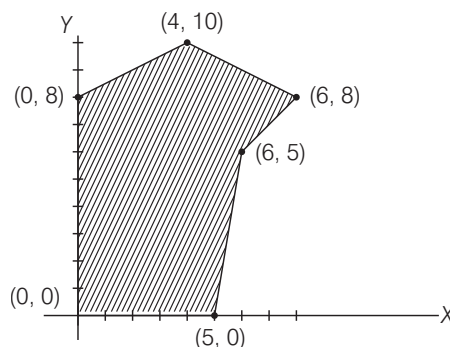

- (a)  $(0, 0)$       (b)  $(0, 8)$       (c)  $(5, 0)$       (d)  $(4, 10)$

**Sol. (b)**

Corner points	Corresponding value of $Z = 3x - 4y$
(0, 0)	0
(5, 0)	15 ← Maximum
(6, 5)	-2
(6, 8)	-14
(4, 10)	-28
(0, 8)	-32 ← Minimum

Hence, the minimum of  $Z$  occurs at (0, 8) and its minimum value is (-32).

**Q. 28** Refer to question 27. Maximum of  $Z$  occurs at

- (a) (5, 0)                      (b) (6, 5)                      (c) (6, 8)                      (d) (4, 10)

**Sol. (a)** Refer to solution 27, maximum of  $Z$  occurs at (5, 0).

**Q. 29** Refer to question 7, maximum value of  $Z$  + minimum value of  $Z$  is equal to

- (a) 13                      (b) 1                      (c) -13                      (d) -17

**Sol. (d)** Refer to solution 27, maximum value of  $Z$  + minimum value of  $Z$   
 $= 15 - 32 = -17$

**Q. 30** The feasible region for an LPP is shown in the following figure. Let  $F = 3x - 4y$  be the objective function. Maximum value of  $F$  is

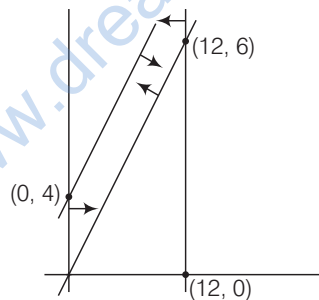

- (a) 0                      (b) 8                      (c) 12                      (d) -18

**Sol. (c)** The feasible region as shown in the figure, has objective function  $F = 3x - 4y$ .

Corner points	Corresponding value of $F = 3x - 4y$
(0, 0)	0
(12, 6)	12 ← Maximum
(0, 4)	-16 ← Minimum

Hence, the maximum value of  $F$  is 12.

**Q. 31** Refer to question 30. Minimum value of  $F$  is

- (a) 0                      (b) -16                      (c) 12                      (d) Does not exist

**Sol. (b)** Referring to solution 30, minimum value of  $F$  is -16 at (0, 4).

**Q. 32** Corner points of the feasible region for an LPP are  $(0, 2)$ ,  $(3, 0)$ ,  $(6, 0)$ ,  $(6, 8)$  and  $(0, 5)$ . Let  $F = 4x + 6y$  be the objective function. The minimum value of  $F$  occurs at

- (a) Only  $(0, 2)$   
 (b) Only  $(3, 0)$   
 (c) the mid-point of the line segment joining the points  $(0, 2)$  and  $(3, 0)$   
 (d) any point on the line segment joining the points  $(0, 2)$  and  $(3, 0)$

**Sol. (d)**

Corner points	Corresponding value of $F = 4x + 6y$
$(0, 2)$	$12 \leftarrow$ Minimum
$(3, 0)$	$12 \leftarrow$ Minimum
$(6, 0)$	$24$
$(6, 8)$	$72 \leftarrow$ Maximum
$(0, 5)$	$30$

Hence, minimum value of  $F$  occurs at any points on the line segment joining the points  $(0, 2)$  and  $(3, 0)$ .

**Q. 33** Refer to question 32, maximum of  $F$  – minimum of  $F$  is equal to

- (a) 60                      (b) 48                      (c) 42                      (d) 18

**Sol. (a)** Referring to the solution 32, maximum of  $F$  – minimum of  $F = 72 - 12 = 60$

**Q. 34** Corner points of the feasible region determined by the system of linear constraints are  $(0, 3)$ ,  $(1, 1)$  and  $(3, 0)$ . Let  $Z = px + qy$ , where  $p, q > 0$ . Condition on  $p$  and  $q$ , so that the minimum of  $Z$  occurs at  $(3, 0)$  and  $(1, 1)$  is

- (a)  $p = 2q$                       (b)  $p = \frac{q}{2}$                       (c)  $p = 3q$                       (d)  $p = q$

**Sol. (b)**

Corner points	Corresponding value of $Z = px + qy; p, q > 0$
$(0, 3)$	$3q$
$(1, 1)$	$p + q$
$(3, 0)$	$3p$

So, condition of  $p$  and  $q$ , so that the minimum of  $Z$  occurs at  $(3, 0)$  and  $(1, 1)$  is

$$p + q = 3p \Rightarrow 2p = q$$

$\therefore$

$$p = \frac{q}{2}$$

## Fillers

**Q. 35** In a LPP, the linear inequalities or restrictions on the variables are called... .

**Sol.** In a LPP, the linear inequalities or restrictions on the variables are called linear constraints.

**Q. 36** In a LPP, the objective function is always... .

**Sol.** In a LPP, objective function is always linear.

**Q. 37** In the feasible region for a LPP is ..., then the optimal value of the objective function  $Z = ax + by$  may or may not exist.

**Sol.** If the feasible region for a LPP is unbounded, then the optimal value of the objective function  $Z = ax + by$  may or may not exist.

**Q. 38** In a LPP, if the objective function  $Z = ax + by$  has the same maximum value on two corner points of the feasible region, then every point on the line segment joining these two points give the same ... value.

**Sol.** In a LPP, if the objective function  $Z = ax + by$  has the same maximum value on two corner points of the feasible region, then every point on the line segment joining these two points give the same maximum value.

**Q. 39** A feasible region of a system of linear inequalities is said to be ..., if it can be enclosed within a circle.

**Sol.** A feasible region of a system of linear inequalities is said to be bounded, if it can be enclosed within a circle.

**Q. 40** A corner point of a feasible region is a point in the region which is the ... of two boundary lines.

**Sol.** A corner point of a feasible region is a point in the region which is the intersection of two boundary lines.

**Q. 41** The feasible region for an LPP is always a ... polygon.

**Sol.** The feasible region for an LPP is always a **convex** polygon.

## True/False

**Q. 42** If the feasible region for a LPP is unbounded, maximum or minimum of the objective function  $Z = ax + by$  may or may not exist.

**Sol.** *True*

**Q. 43** Maximum value of the objective function  $Z = ax + by$  in a LPP always occurs at only one corner point of the feasible region.

**Sol.** *False*

**Q. 44** In a LPP, the minimum value of the objective function  $Z = ax + by$  is always 0, if origin is one of the corner point of the feasible region.

**Sol.** *False*

**Q. 45** In a LPP, the maximum value of the objective function  $Z = ax + by$  is always finite.

**Sol.** *True*